



# **Synthesis of Spacecraft Designs**

**Erik K. Antonsson, Ph.D., P.E.**

**Executive Officer and Professor of Mechanical Engineering**

**Division of Engineering and Applied Science**

**California Institute of Technology**

**Pasadena, CA 91125**

**April 30, 1998**



**Engineering Design Research Laboratory**

# Traditional Design Process

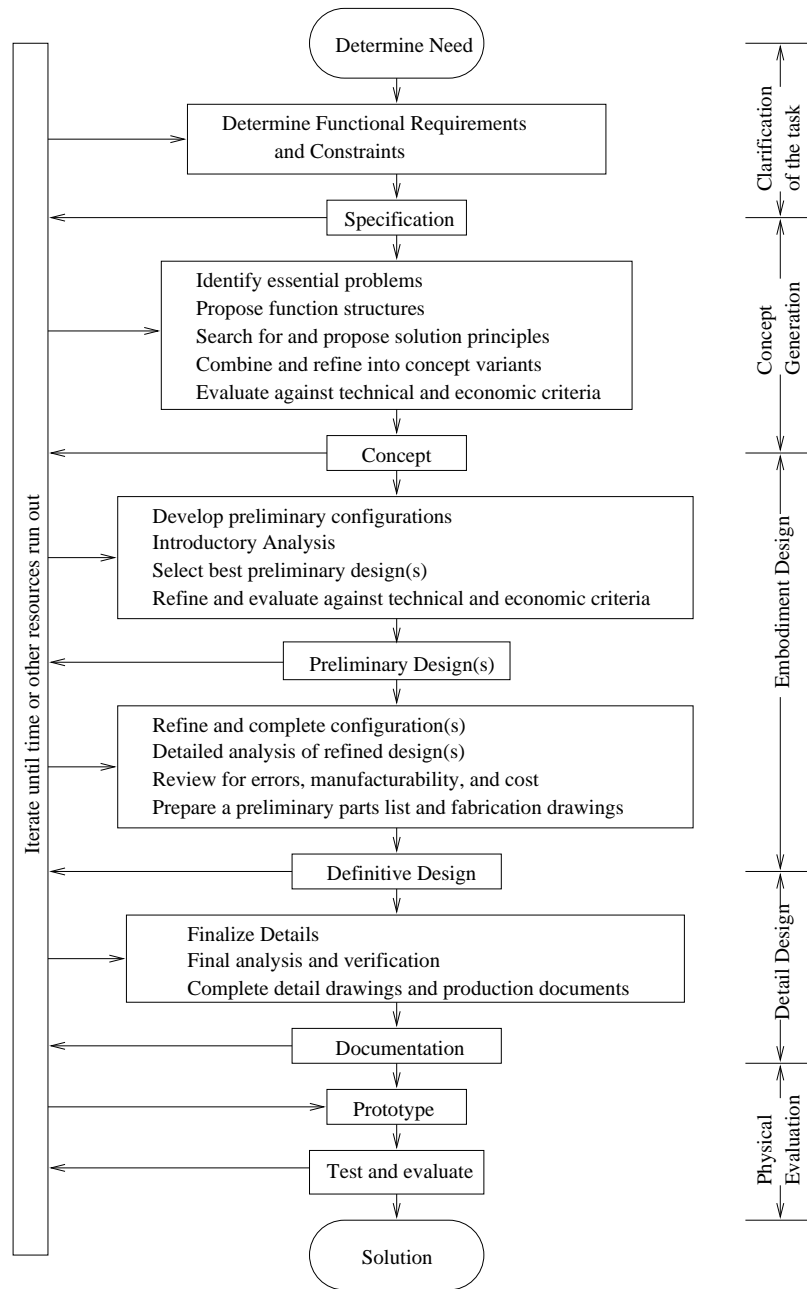

Adapted from:  
 G. Pahl and W. Beitz  
*Engineering Design*  
 The Design Council, Springer-Verlag  
 New York, 1984, page 41

# APPROACH

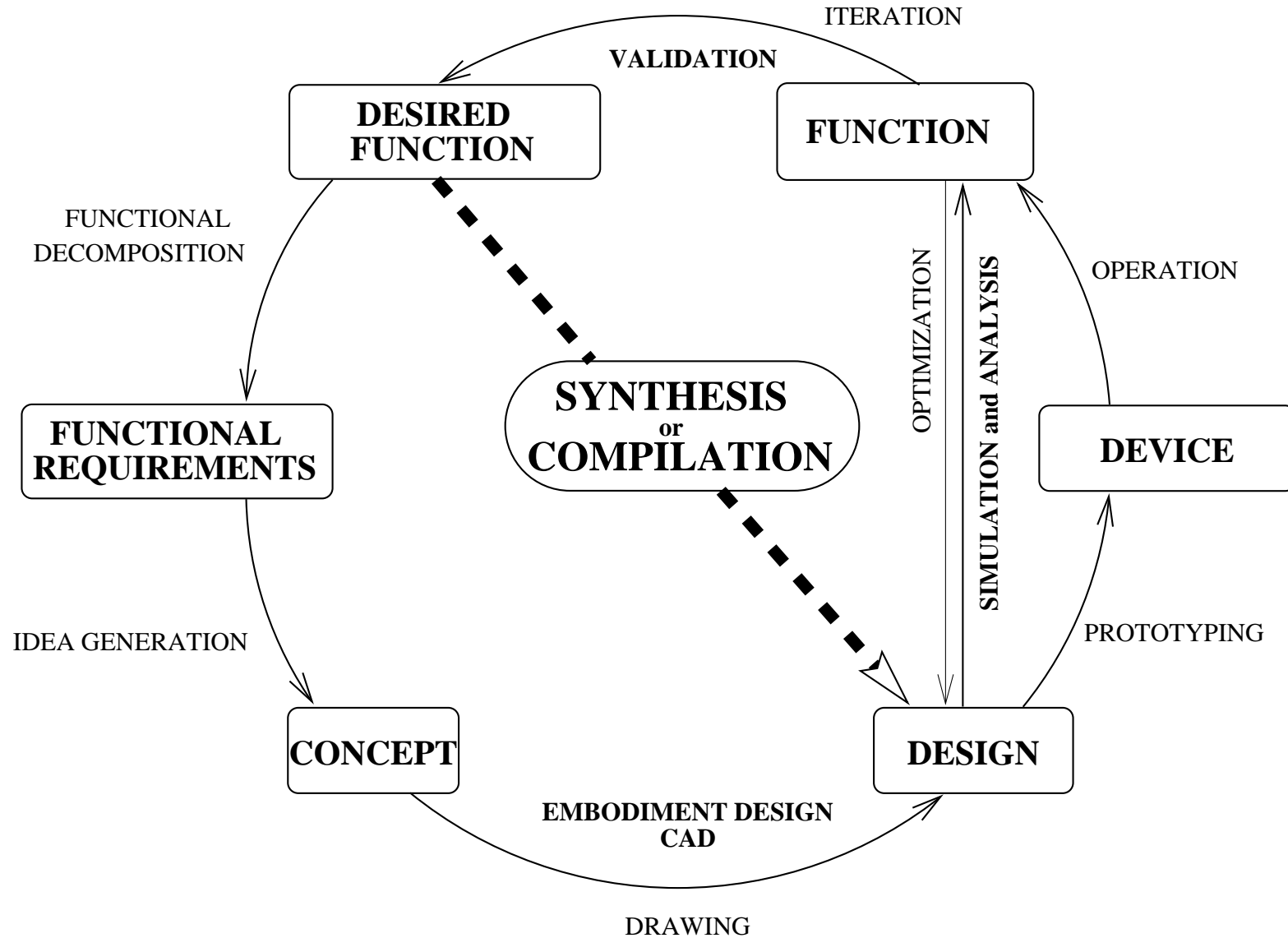

**A New Approach to Synthesis is needed to Achieve One Launch/Month.**

**syn.the.sis** *n, pl -the.ses* [Gk, fr. *syntithenai* to put together, fr. *syn-* + *tithenai* to put, place—more at do] (1589)

**1 a:** the composition or combination of parts or elements so as to form a whole

**1 b:** the production of a substance by the union of chemical elements, groups, or simpler compounds or by the degradation of a complex compound

**1 c:** the combining of often diverse conceptions into a coherent whole; also: the complex so formed

**2 a:** deductive reasoning

**2 b:** the dialectic combination of thesis and antithesis into a higher stage of truth

**3:** the frequent and systematic use of inflected forms as a characteristic device of a language – **syn.the.sist** *n*

Merriam-Webster's Collegiate Dictionary

Copyright ©1994 Merriam-Webster, Incorporated

**com.pile** *vt* **com.piled** ; **com.pil.ing** [ME, fr. MF *compiler*, fr. L *compilare* to plunder] (14c)

**1:** to compose out of materials from other documents

**2:** to collect and edit into a volume

**3:** to run (as a program) through a compiler

**4:** to build up gradually <compiled a record of four wins and two losses>

**com.pil.er** *n* (14c)

**1:** one that compiles

**2:** a computer program that translates an entire set of instructions written in a higher-level symbolic language (as Pascal) into machine language before the instructions can be executed

**com.pi.la.tion** *n* (15c)

**1:** the act or process of compiling

**2:** something compiled

# Software Compilation

<pre>#include &lt;stdio.h&gt; #include &lt;math.h&gt;  main() {     float x,y;     x = 30.0*3.14159/180.0;     y = sin(x);     printf("%f \n", y); }</pre>	<pre>.file "jpl.c" gcc2_compiled.: .section ".rodata" .align 8 .LLC1: .asciz "%f \n" .align 4 .LLC0: .long 0x3f060a8a .section ".text" .align 4 .global main .type main,#function .proc 04 main: !#PROLOGUE# 0 save %sp,-120,%sp !#PROLOGUE# 1 sethi %hi(.LLC0),%o0 ld [%o0+%lo(.LLC0)],%o1 st %o1,[%fp-20] ld [%fp-20],%f2 fstod %f2,%f6 std %f6,[%fp-16] ldd [%fp-16],%o2 mov %o2,%o0 mov %o3,%o1 call sin,0 nop fmovs %f0,%f2 fmovs %f1,%f3 fdtos %f2,%f4 st %f4,[%fp-24] ld [%fp-24],%f2 fstod %f2,%f6 std %f6,[%fp-16] ldd [%fp-16],%o2 sethi %hi(.LLC1),%o1 or %o1,%lo(.LLC1),%o1 mov %o2,%o1 mov %o3,%o2 call printf,0 nop .LL1: ret restore .LLfel: .size main,.LLfel-main .ident "GCC: (GNU) 2.7.2.3"</pre>	<pre>00000000 7f454c46 01020100 00000000 00000000 00000020 00020002 00000001 000105fc 00000034 00000040 0000120c 00000000 00340020 00050028 00000060 00190017 00000006 00000034 00010034 00001000 00000000 000000a0 000000a0 00000005 00001200 00000000 00000003 000000d4 00000000 ... 00064400 00612e6f 75740063 7274692e 73007661 00064460 6c756573 2d58612e 63006372 74737475 00065000 66662e63 005f5f43 544f525f 4c495354 00065200 5f5f005f 5f44544f 525f4c49 53545f5f 00065400 005f5f64 6f5f676c 6f62616c 5f64746f 00065600 72735f61 75780067 6363325f 636f6d70 00066000 696c6564 2e00666f 7263655f 746f5f64 00066200 61746100 66696e69 5f64756d 6d79006a 00066400 706c2e63 00676363 325f636f 6d70696c 00066600 65642e00 63727473 74756666 2e63005f 00067000 5f646f5f 676c6f62 616c5f63 746f7273 00067200 5f617578 00676363 325f636f 6d70696c 00067400 65642e00 666f7263 655f746f 5f646174 00067600 6100696e 69745f64 756d6d79 005f5f44 00070000 544f525f 454e445f 5f005f5f 43544f52 00070200 5f454e44 5f5f0063 72746e2e 73005f73 00070400 74617274 005f5354 4152545f 005f656e 00070600 7669726f 6e005f65 6e64005f 474c4f42 00071000 414c5f4f 46465345 545f5441 424c455f 00071200 00617465 78697400 65786974 005f696e 00071400 6974005f 454e445f 005f4459 4e414d49 00071600 43007072 696e7466 005f6578 69740065 00072000 6e766972 6f6e005f 65646174 61005f50 00072200 524f4345 44555245 5f4c494e 4b414745 00072400 5f544142 4c455f00 5f657465 7874005f 00072600 ... 00126600 00000000 00001009 000000c5 00000000 00127000 00000000 00000001 00000000 000000b6 00127200 00000003 00000000 00000000 000010ce 00127400 0000013b 00000000 00000000 00000001 00127600 00000000 00127640</pre>
--	--	---

**C code**

**Assembly code**

**Machine code**

## Digital VLSI Compilation

- Specify Desired (Boolean Logic) Function
- Automated Procedures to produce Mask-Layouts from standard components (logic gates, shift registers, memory cells, etc.)

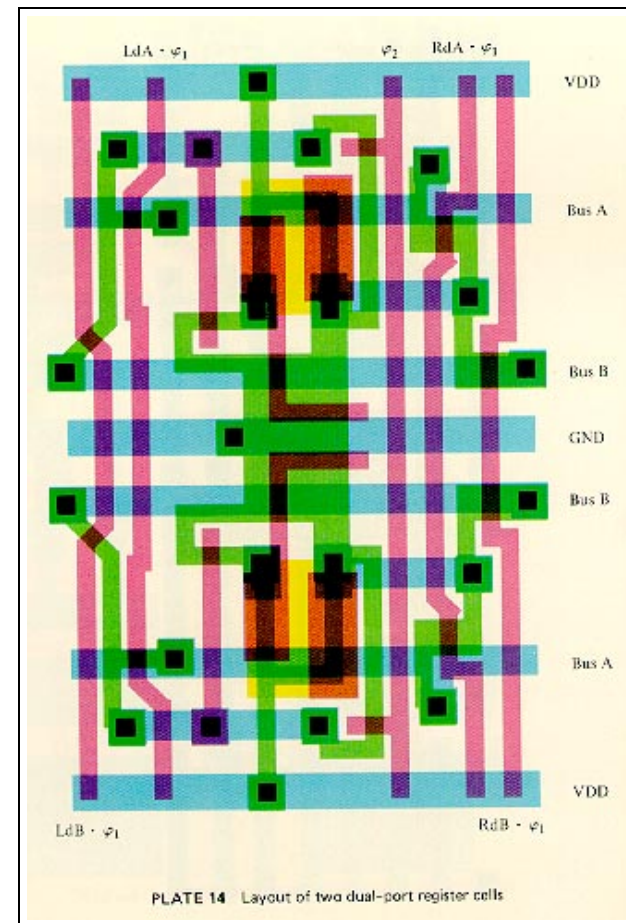
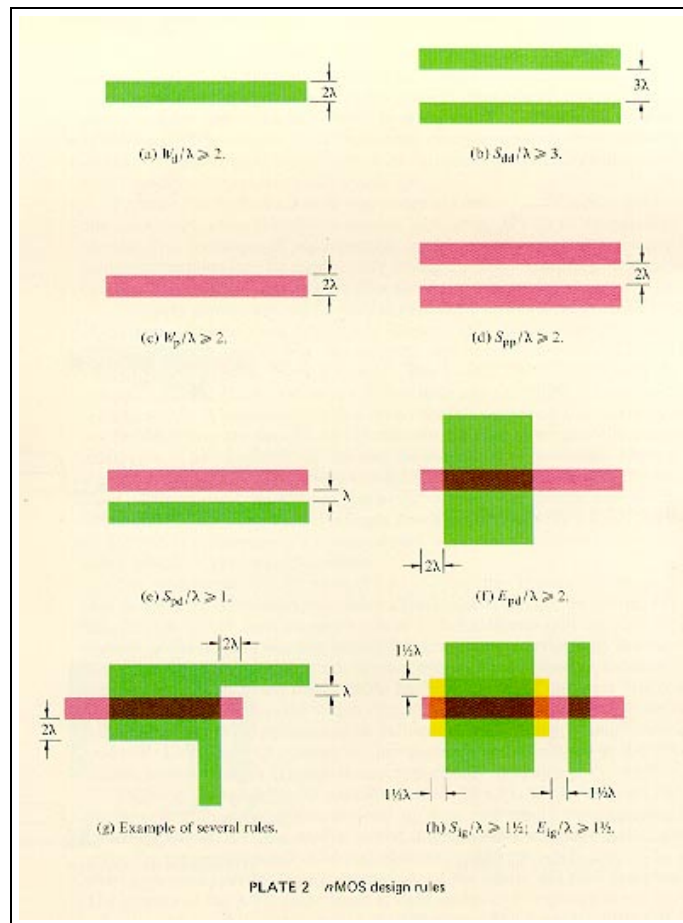

(Mead and Conway, *Introduction to VLSI Systems*, 1980)

## **Chemical Process Plant Compilation**

- Specify Desired Chemical Process Function
- Automated Procedures to produce Plant Flow-Chart from standard components (reactors, pumps, distillation columns, etc.)

## Hand-held Electric Drill Compilation

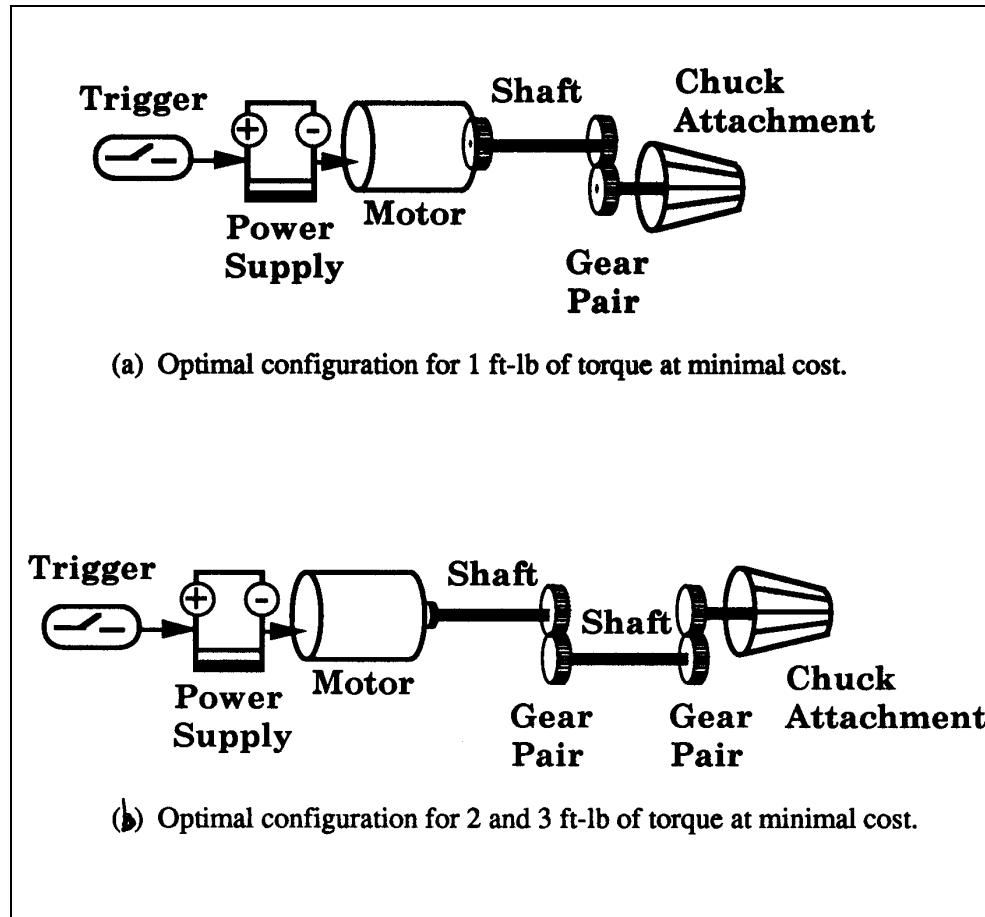

**Figure 5. FFREADA's optimal design configurations**

(Schmidt and Cagan, "Configuration Design: An Integrated Approach Using Grammars", *Proceedings of The 1996 ASME Design Engineering Technical Conferences and Computers in Engineering Conference*, August 18-22, 1996, Irvine, California, paper number 96-DETC/DTM-1511)

## HVAC Layout Compilation

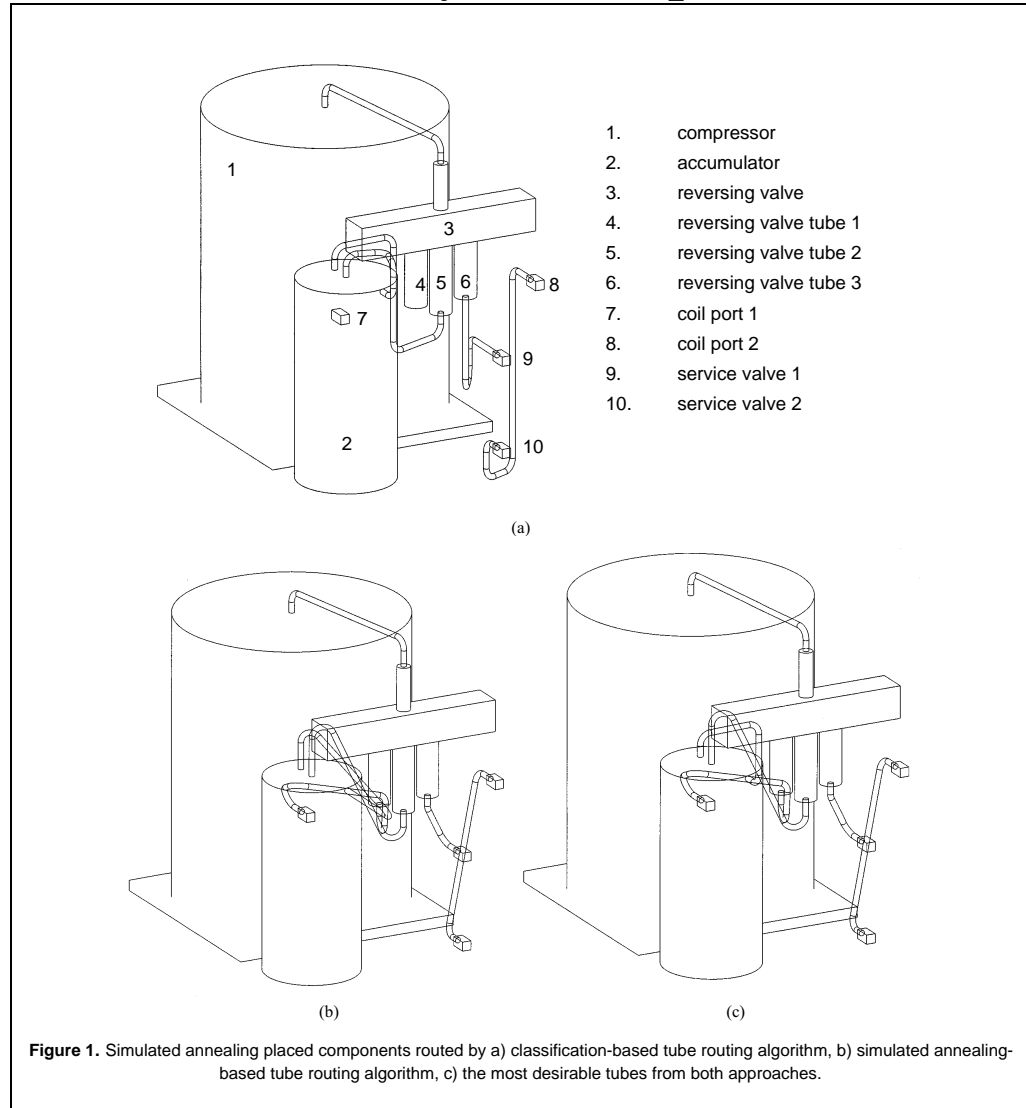

(Cagan *et al.*, "HVAC CAD Layout Tools: A Case Study of University/Industry Collaboration, *Proceedings of The 1996 ASME Design Engineering Technical Conferences and Computers in Engineering Conference*, August 18-22, 1996, Irvine, California, paper number 96-DETC/DTM-1505)

# Mechanical/Hydraulic System Compilation





parts	variables represented	
 electric motors	power type voltage current power	rpm efficiency torque
 mechanical transmissions	torque-out torque-in rpm-out rpm-in	power-out power-in efficiency
 ball screws	rpm lead speed torque	force critical rpm buckling load length
 hydraulic cylinders	diameter pressure force	flow speed
 hydraulic pumps	rpm flow power pressure	displacement total efficiency volumetric efficiency
 hydraulic valves	flow-in flow-out pressure-out power-out	valve-coefficient flow-return pressure-in power-in
 speed controlled motors	power type voltage current power	rpm efficiency torque

Figure 4: Some test parts

The optimum solution, with cost 441.97, is:  
 For POWER-SUPPLY, US-3Ph-220 with cost 0  
 For MOTOR, 3N593 with cost 192.72  
 For GEAR-PUMP, TYPE-103 with cost 133.0  
 For VALVE, TYPE-1 with cost 50.0  
 For CYLINDER, 1.25 with cost 6.25  
 For VALVE-2, TYPE-1 with cost 50.0  
 For CYLINDER-2, diameter 2.0 with cost 10.0

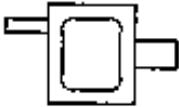
(Ward and Seering, "The Performance of a Mechanical Design Compiler", MIT Artificial Intelligence Laboratory memo 1084, 1989)

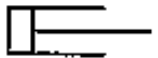
## **Current Related Work at Caltech**

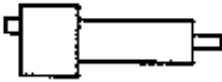
- Refinement of Design Imprecision (Fuzzy Sets)
- Set-Based Design
- Rapid Assessment of Early Designs (RAED)
- Genetic Algorithms in MEMS Synthesis
- Compilers for Mechanical Systems

# Current Related Work at Caltech

## Refinement of Design Imprecision (Fuzzy Sets)

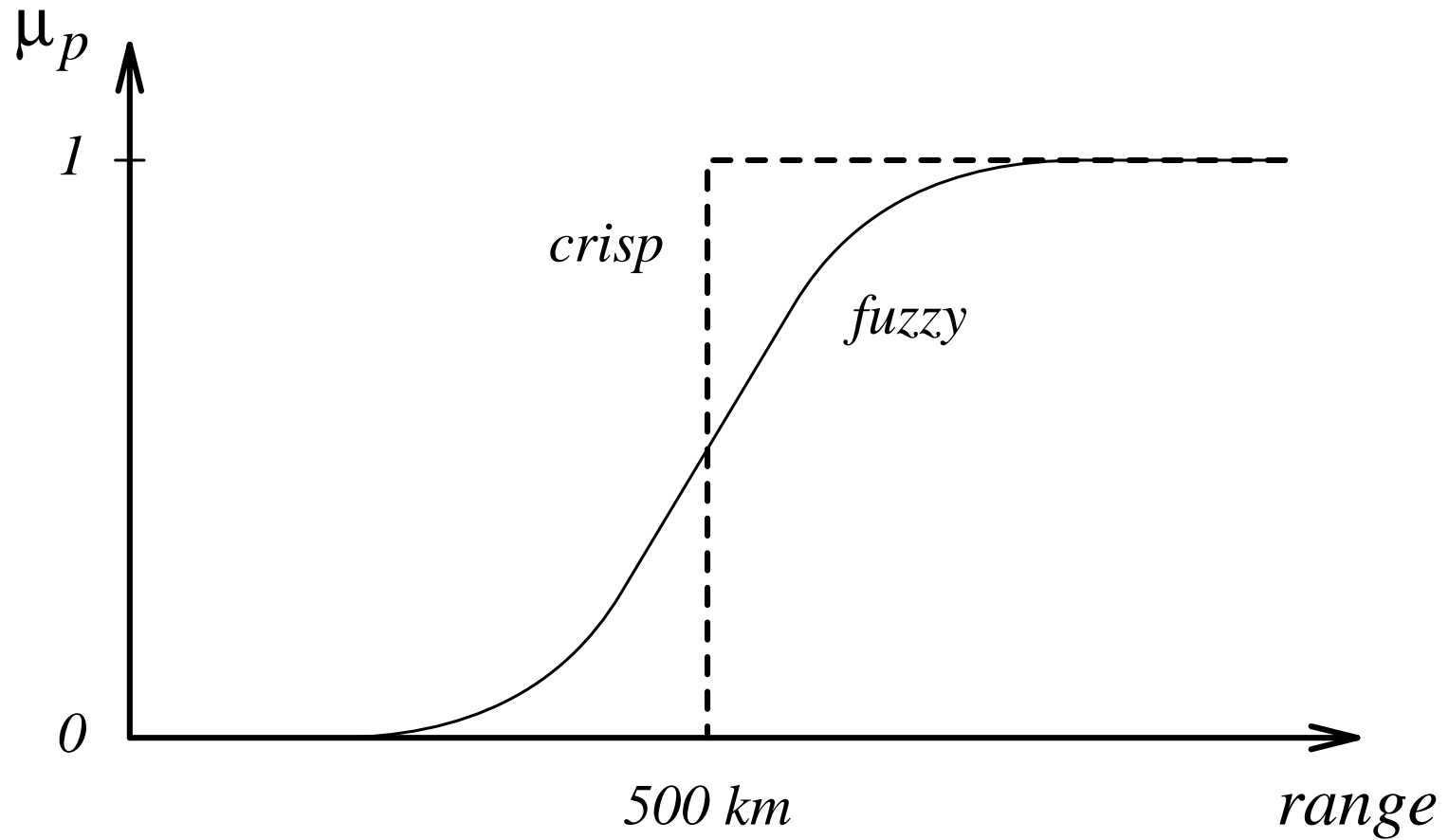

# Current Related Work at Caltech

## (Fuzzy) Set-Based Design

DVS

(Design Variable Space)

PVS

(Performance Variable Space)

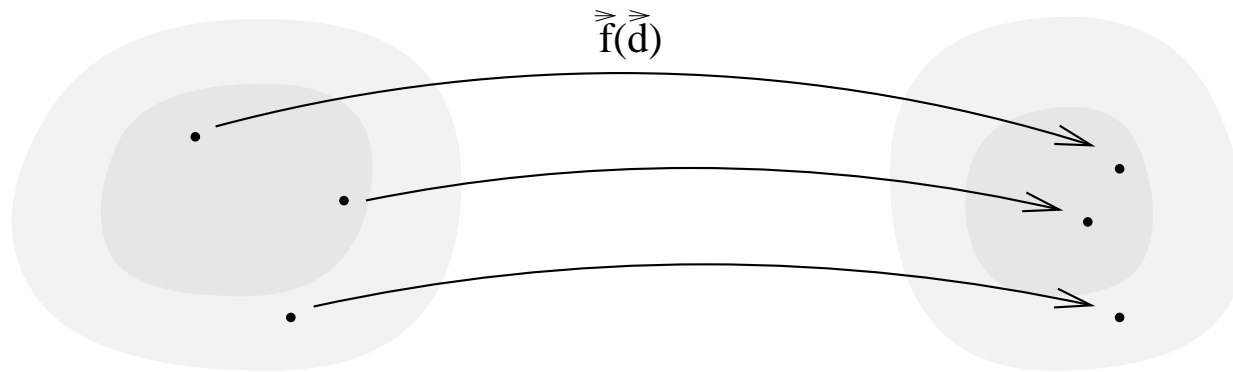

**Design Exploration  
Point by Point**

DVS

PVS

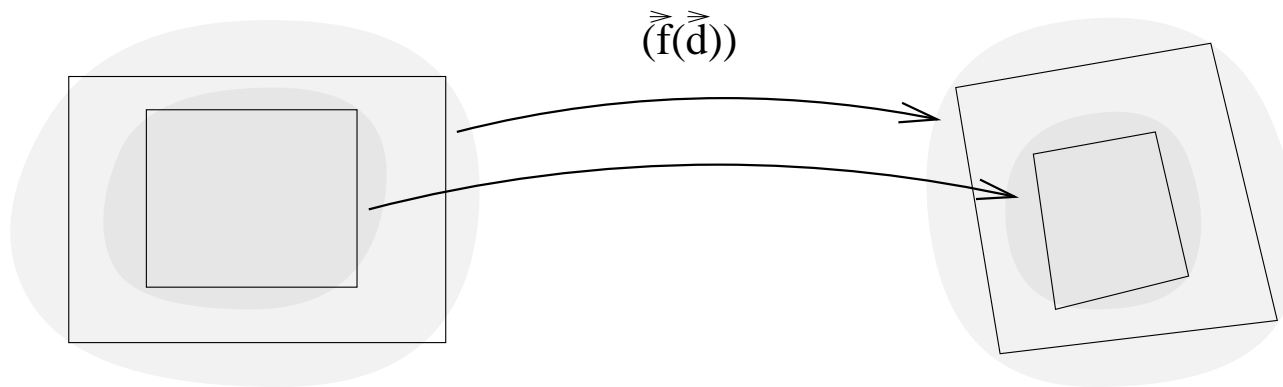

**Design Exploration  
Sets at a Time**

## Current Related Work at Caltech

### Rapid Exploration of a Large Design Space

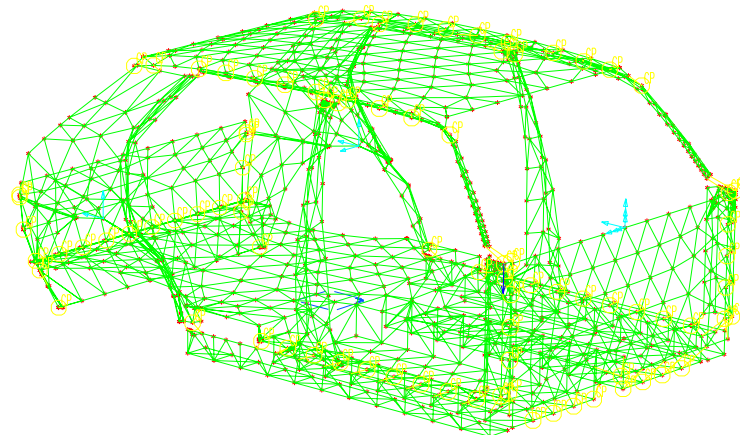
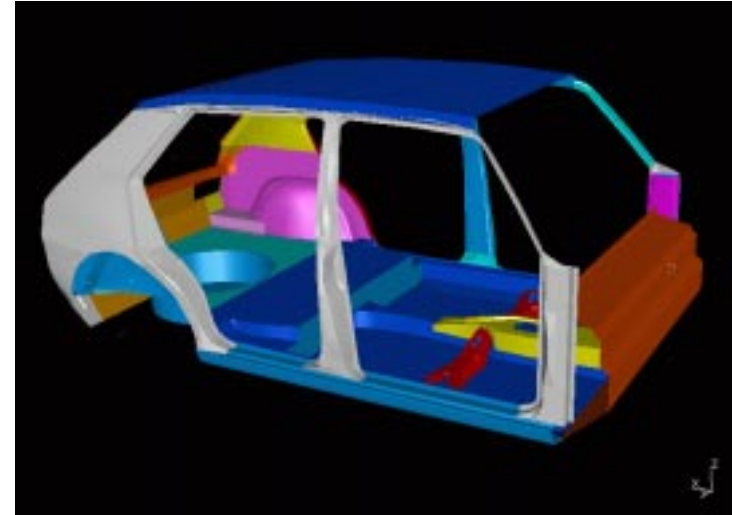

# Current Related Work at Caltech

## Rapid Exploration of a Large Design Space

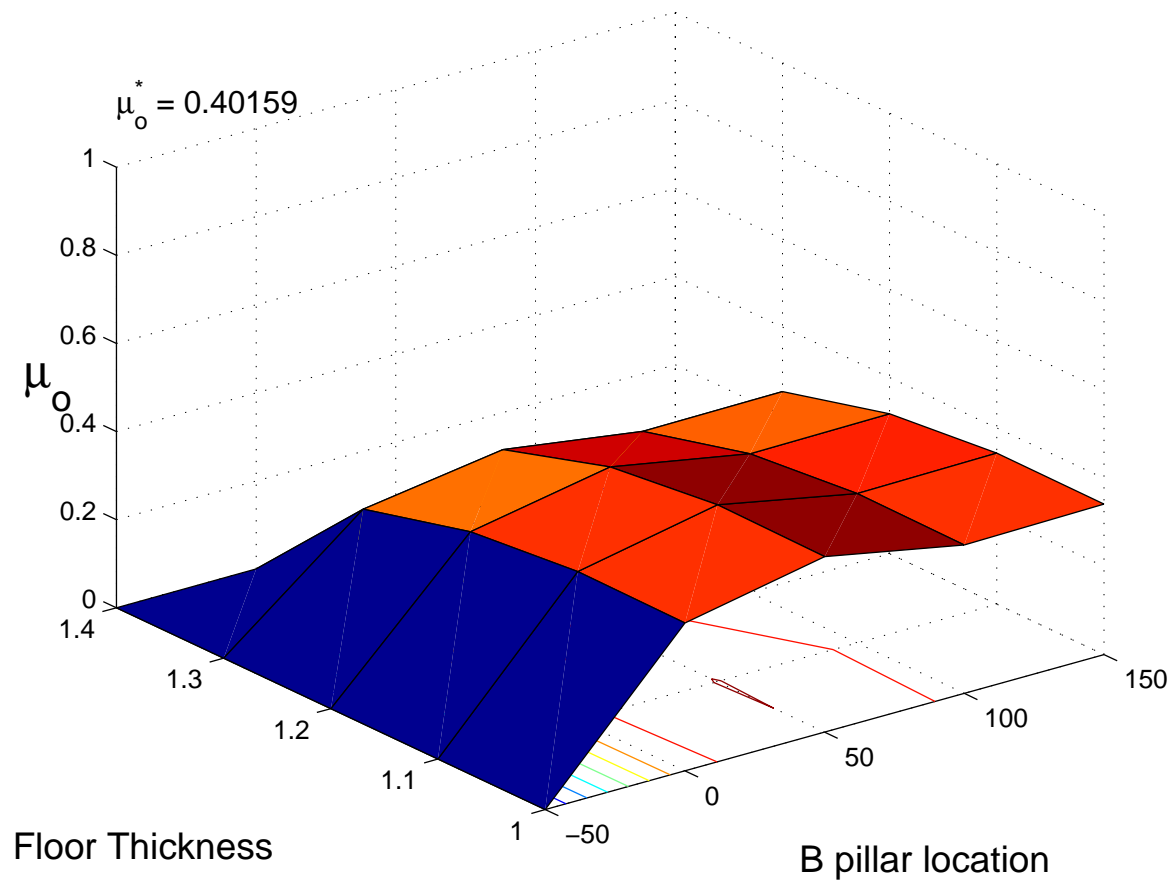

```
MiniCommand Window
global DATA
dv(1) = 0.7; i1=1;
```

A vertical control panel with the following elements:

- A Pillar Thickness: 0.7
- B Pillar Thickness: 1.1
- Floor Rail Thickness: 0.8
- Floor Thickness: free
- B Pillar Location: free
- Info and Prefs buttons
- X, Y, and Iso view buttons
- Close button

# Current Related Work at Caltech

## Rapid Exploration of a Large Design Space

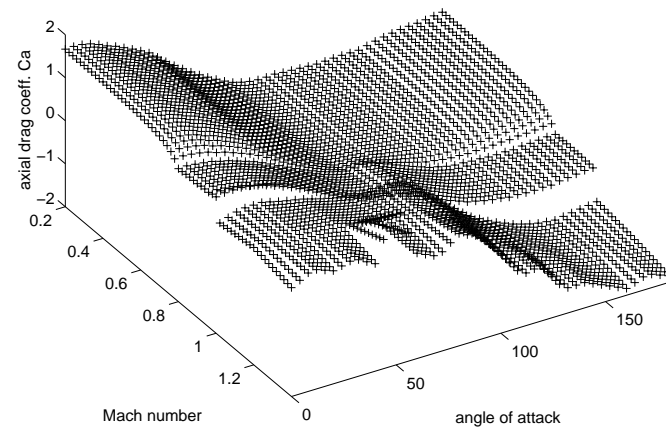
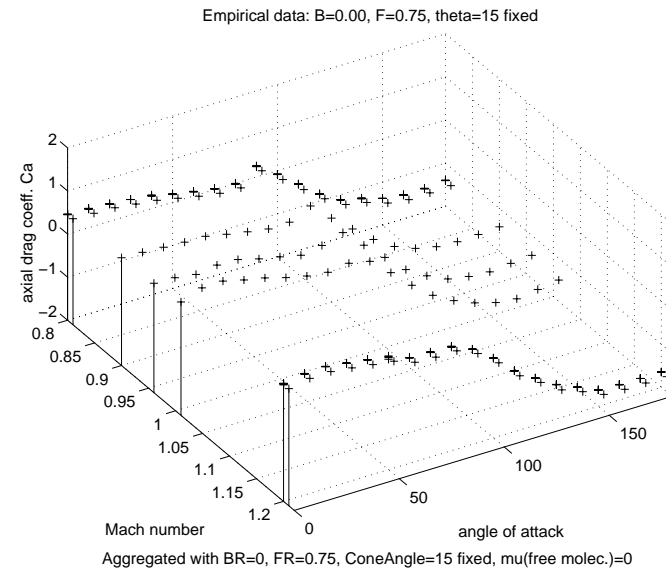
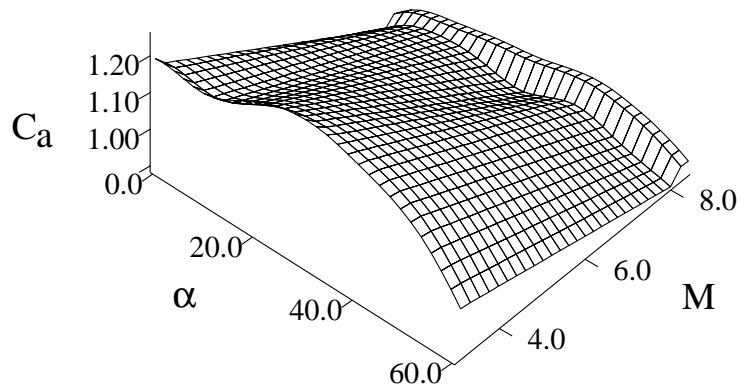
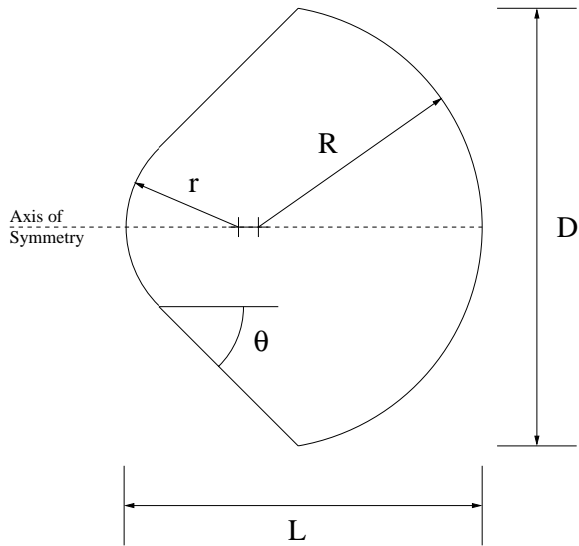

## Current Work Elsewhere

- “Recursive Annealing: A Computational Model for Machine Design”, Jon Cagan, CMU
- “Constrained Three Dimensional Component Layout Using Simulated Annealing”, Jon Cagan, CMU
- “Agent-Based Design”, Jon Cagan, CMU
- “Using Pareto optimality to coordinate distributed agents”, Mark Cutkosky, Stanford
- “Set-Based Concurrent Engineering”, Al Ward, U.Michigan
- “Chain Models of Physical Behavior for Engineering Analysis and Design”, Vadim Shapiro, U.Wisconsin, Madison
- “Synthesis of Schematic Descriptions in Mechanical Engineering”, Warren Seering, MIT
- “Genetic Algorithm Attributes for Component Selection”, Susan Carlson
- “Quantitative Inference in a Mechanical Design Compiler”, Al Ward, U.Michigan
- “An Architecture for Exploring Large Design Spaces”, John Josephson and B. Chandrasekaran, *et al.*, Ohio State
- “Structured Synthesis for MEMS”, Gary Fedder, CMU

## Current Work Elsewhere

*9th Int'l Conf. on Solid State Sensors and Actuators (Transducers '97)*  
Chicago, IL, June 1997, pp. 1109-1112.

# Automated Optimal Synthesis Of Microresonators

G. K. Fedder, S. Iyer and T. Mukherjee  
Department of Electrical and Computer Engineering and The Robotics  
Institute  
Carnegie Mellon University, Pittsburgh, Pennsylvania 15213-3890

---

### ABSTRACT

The rapid layout synthesis of a microresonator from high-level functional specifications and design constraints is demonstrated. Functional parameters such as resonant frequency, quality factor, and displacement amplitude at resonance are satisfied while simultaneously minimizing an objective function. The optimal synthesis tool allows exploration of micromechanical design issues and objectives, as illustrated with a polysilicon lateral resonator example modeled in three mechanical degrees-of-freedom. Layouts for three sets of five different resonators from 3 kHz to 300 kHz are generated, with each set globally optimized to minimize either active device area, electrostatic drive voltage, or a weighted combination of area and drive volt- $\mu$ sec.

## **Current Work Elsewhere**

### **OPTIMIZED PORTABLE ALGORITHMS AND APPLICATION LIBRARIES (OPAAL) INITIATIVE FOR COMPLEX PHYSICAL SIMULATION**

*Algorithms And Libraries For Virtual Prototyping And Simulation*

*DEADLINES:*

*May 22, 1998: e-mail letter of intent*

*July 1, 1998: Proposal receipt*

*NSF 98-64*

#### *INTRODUCTION*

The Division of Mathematical Sciences (in collaboration with the Office of Multidisciplinary Activities of the Directorate for Mathematical and Physical Sciences, the Directorate for Computer and Information Science and Engineering (CISE) and the Directorate for Engineering (ENG)) of the National Science Foundation (NSF) and the Defense Sciences Office of the Defense Advanced Projects Research Agency (DARPA) plan jointly to support research and development of new approaches to the design and creation of efficient algorithms and optimized libraries for large-scale numerical modeling and simulation of physical phenomena arising in industrial applications.

The Optimized Portable Algorithm and Application Libraries (OPAAL) initiative is an opportunity for researchers in the mathematical sciences to join with other scientists and engineers in the development of innovative mathematical techniques applicable to simulation of complex physical processes. Fresh ideas, approaches, techniques, the formation of new teams, and the participation of researchers new to such problem areas are particularly encouraged. Areas of mathematics which are not currently considered “applied” are a likely source of such fresh ideas, approaches and techniques.

## Current Work Elsewhere

### NSF/DARPA OPAAL Continued . . .

The use of modeling and simulation by industry to speed up and reduce the cost of design of new products and systems has become a well-accepted paradigm in many areas, with explosive growth expected in the years to come. The ability to reduce the amount of “cut and try” in design will depend on the accuracy, speed, robustness, and affordability of computational alternatives.

Major bottlenecks in numerical simulation include geometry representation, grid generation, the accuracy of numerical solutions of partial differential equations, and the efficiency and speed of numerical methods when implemented on specific computer architectures. Areas of “core” mathematics playing potential roles here would be geometry, analysis and algebra. Historically, it has been difficult to realize algorithms that simultaneously guarantee low computational complexity, low memory usage, accuracy, high efficiency, and portability across diverse computer architectures. Algorithmic design is further complicated by the disparity in mathematical, computational, and application considerations that often work at cross purposes when addressed in a sequential or compartmentalized fashion. In addition, the labor intensive nature of implementing numerical methods to run efficiently on modern platforms having deep memory hierarchies and multiprocessor architectures results in significant costs and delays for the applications community.

Major technical themes of the initiative include:

- Mathematical representations of complex surfaces and volumes to facilitate Computer Aided Design (CAD) and discretization;
- Well-conditioned, scalable, high order accurate numerical methods;
- Mathematical abstractions and computational models for automatic generation of OPAAL; and
- Demonstrations and technology transfer.

## Current Work: DARPA RaDEO Program

- Design Exploration and Advanced Design Representations
  - Design Space Colonization, Stanford University
  - Automated Capture of Design Rationale, SRI
  - Design Information Retrieval Using Geometric Content, Virage, Inc.
  - Model-based Support of Distributed Collaborative Design, p Stanford University
  - Functional and Diagrammatic Representations for Device Libraries, Ohio State University
  - Context Integrated Design, Lockheed Martin
  - Development of an Adaptive Modeling Language for Knowledge Based Engineering with Application to Interactive Gimbal Design, Lockheed Martin Electronics and Missiles
  - MADEsmart, Boeing D&S Helicopters Division
  - Generative Design, Boeing

Kevin W. Lyons  
DARPA/DSO  
3701 N. Fairfax Drive  
Arlington, VA 22203-1714

Email: [klyons@darpa.mil](mailto:klyons@darpa.mil)  
Phone: (703) 696-2314  
Fax: (703) 696-3999

# Current Work: DARPA RaDEO Program

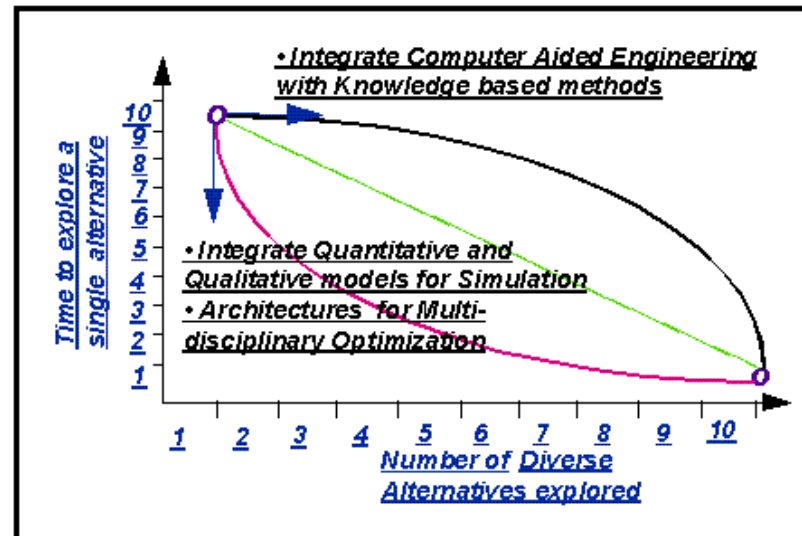
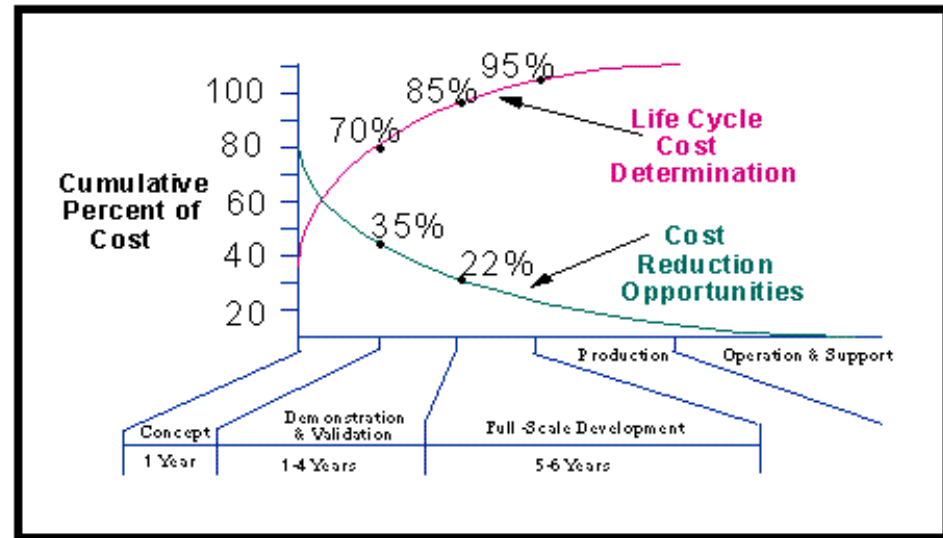
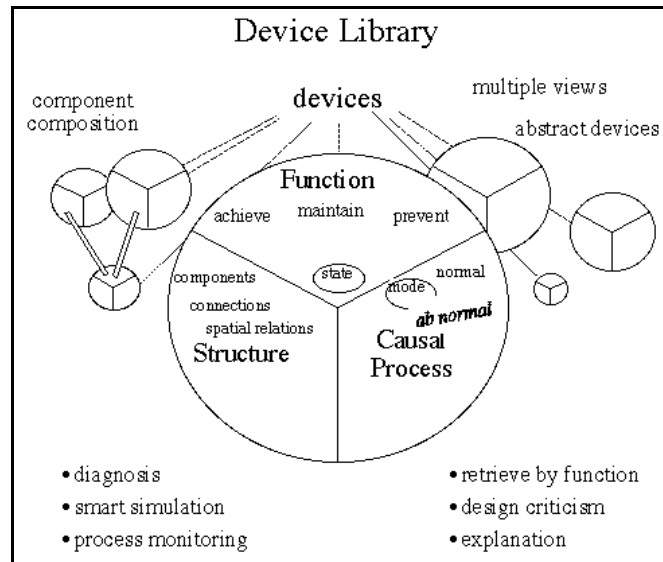

## **Proposed Work: NASA ISE Program**

- Automatic Synthesis/Compilation of Spacecraft Configuration/Design
  - Parameterized Modules
  - Choose Modules
  - Choose Parameters
- Automatic Synthesis/Compilation of Mechanical Transmissions

# Sobieski Paradox (1988)

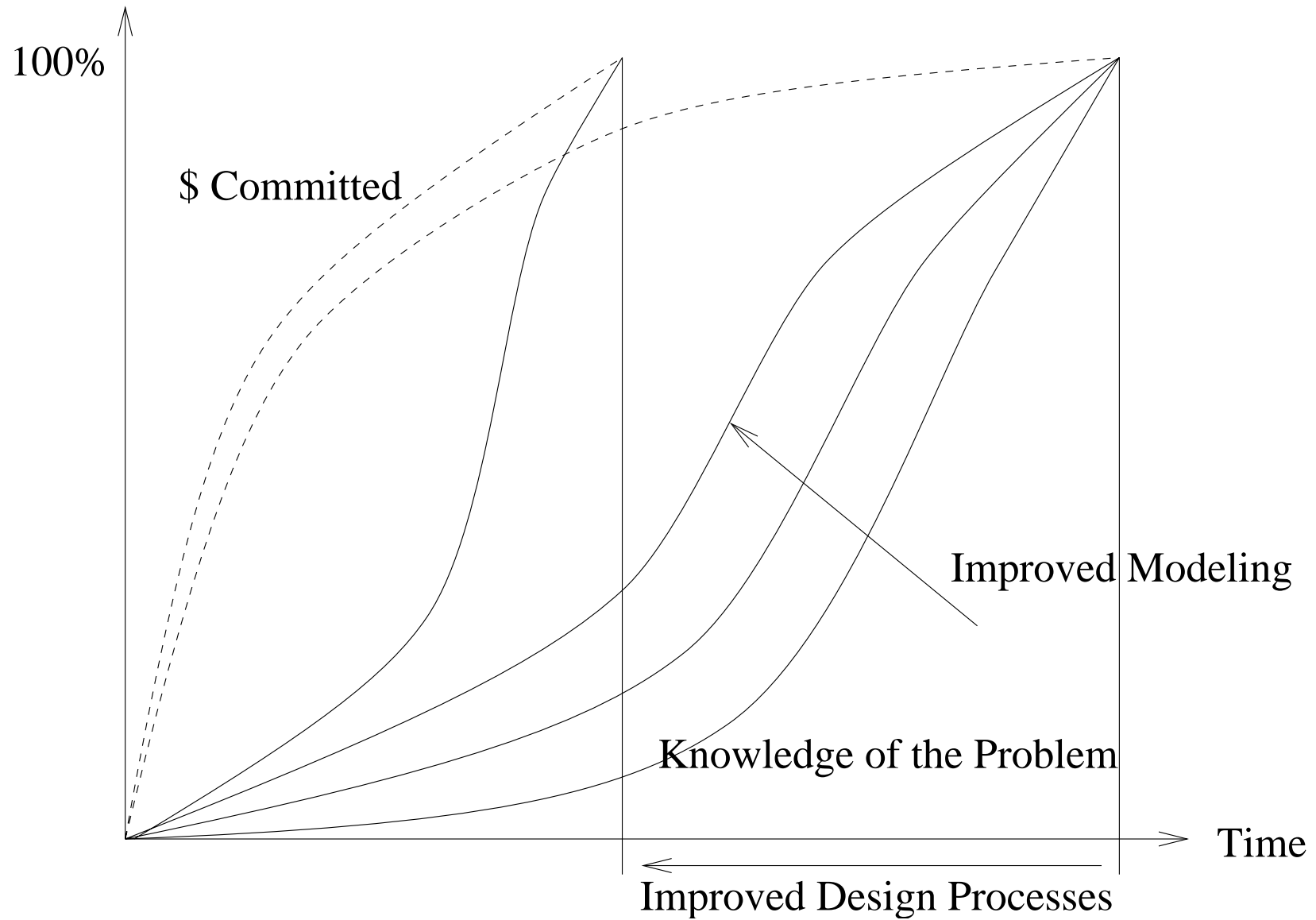

## ISE Improvement Measure

