

<111> masks merge

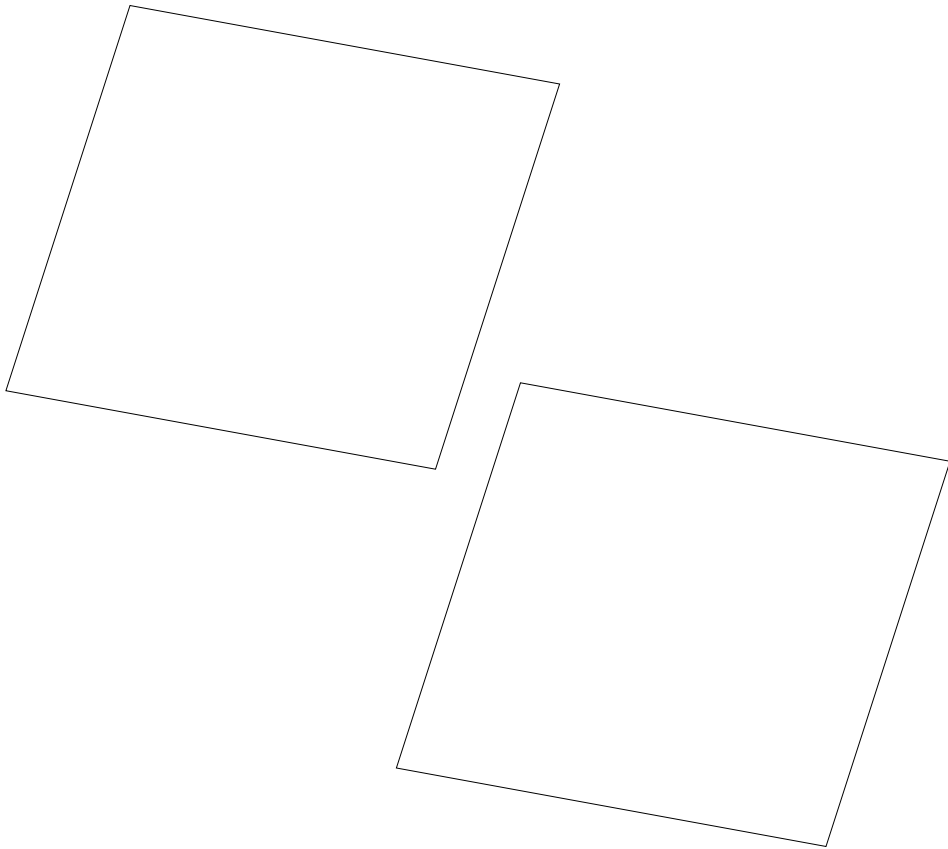

TIME: 0

<111> masks merge

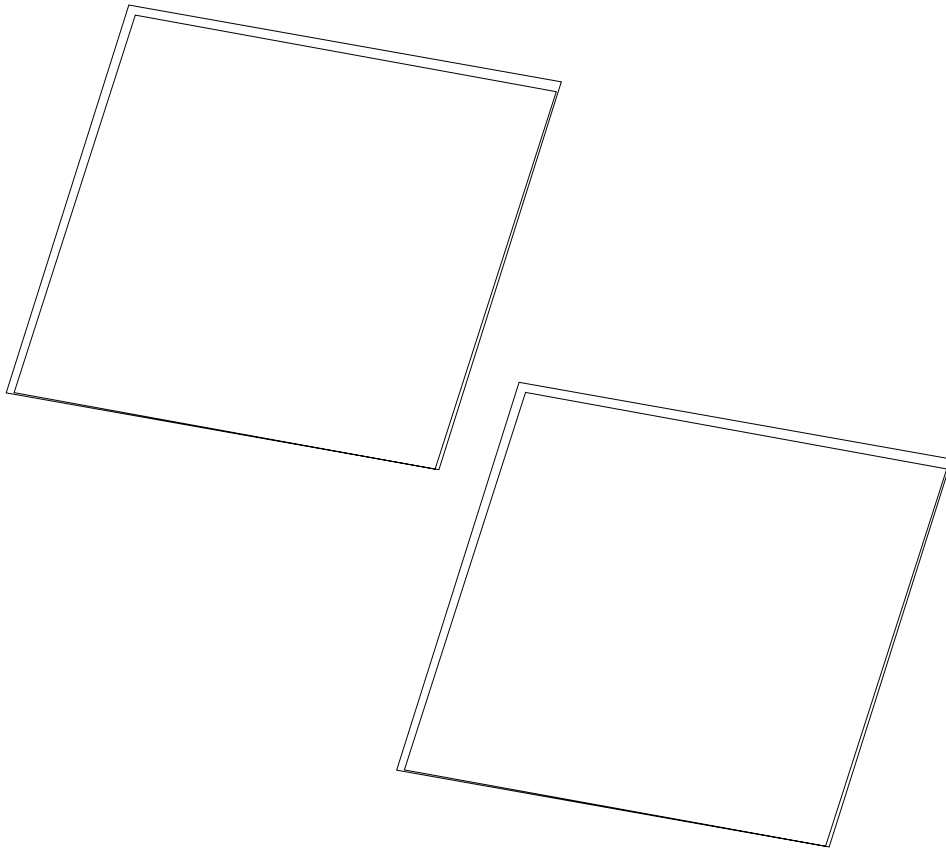

TIME: 1

<111> masks merge

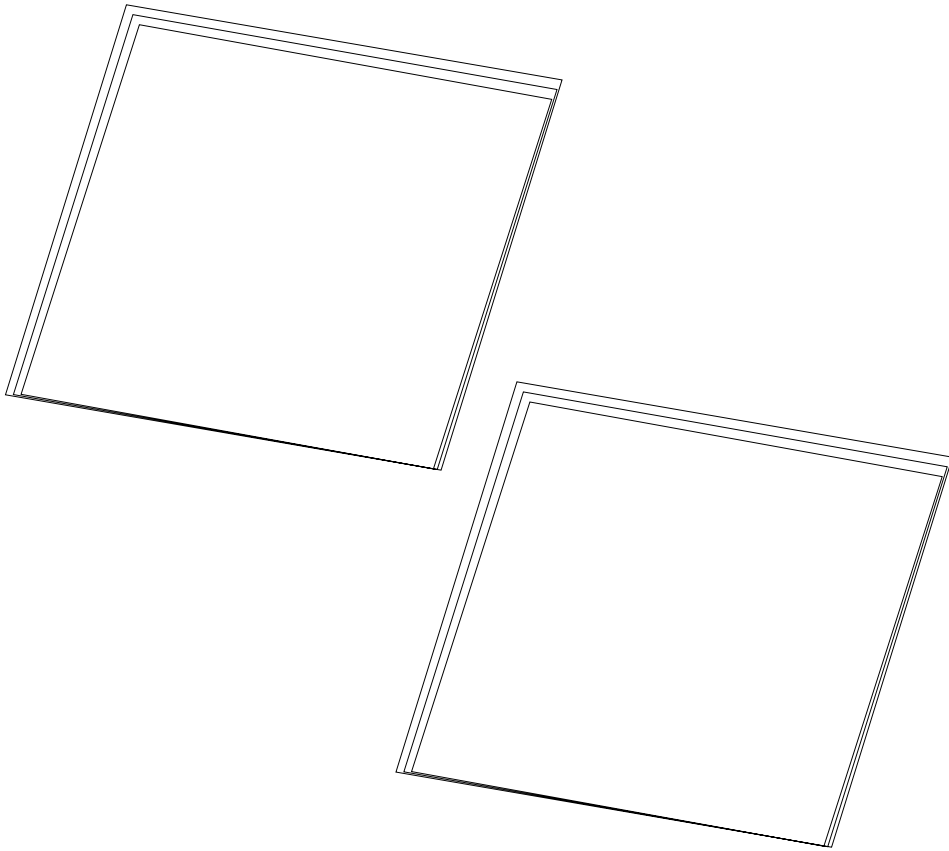

TIME: 2

<111> masks merge

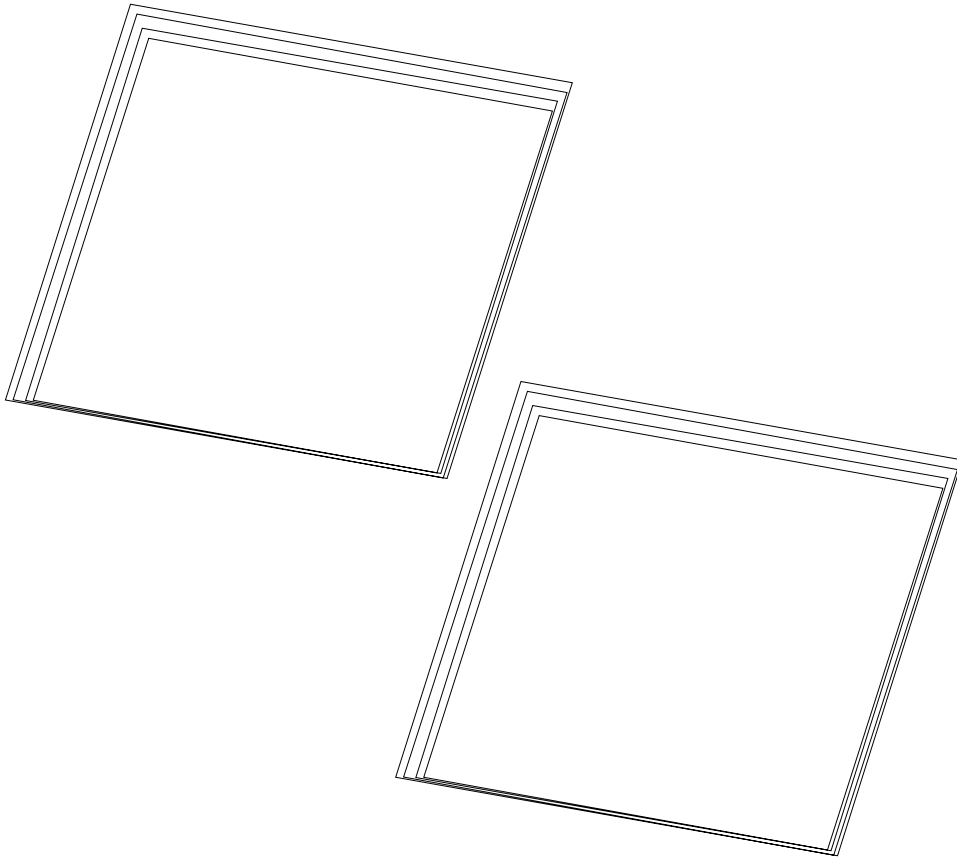

TIME: 3

<111> masks merge

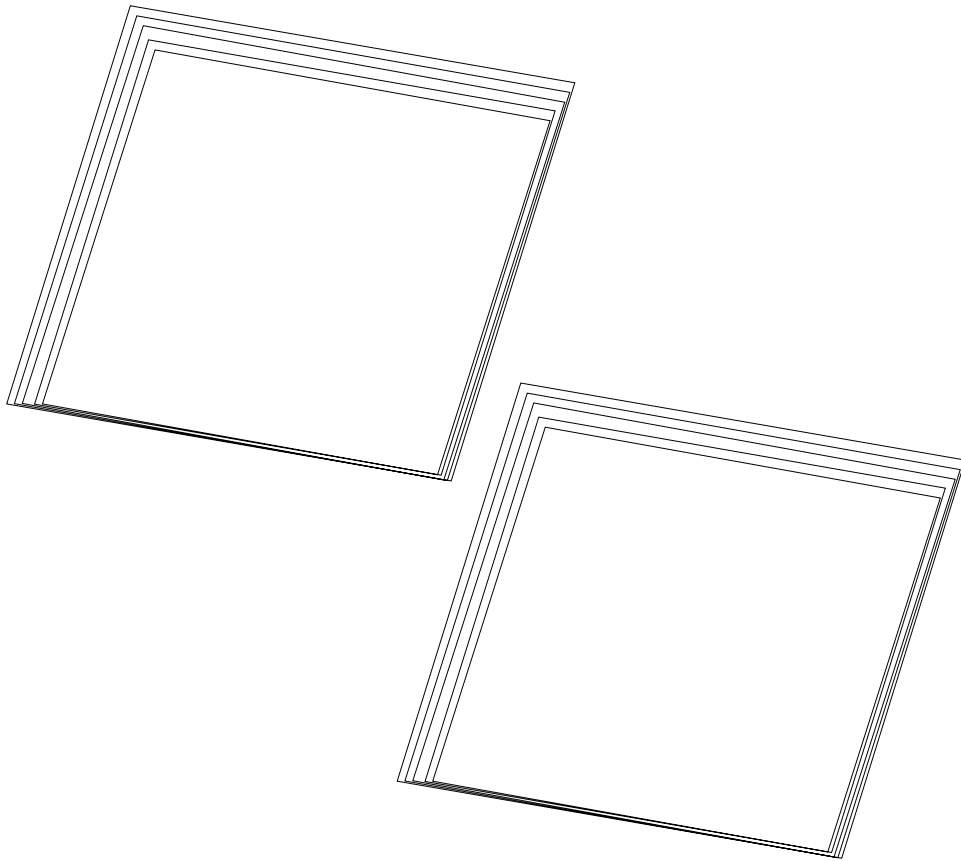

TIME: 4

<111> masks merge

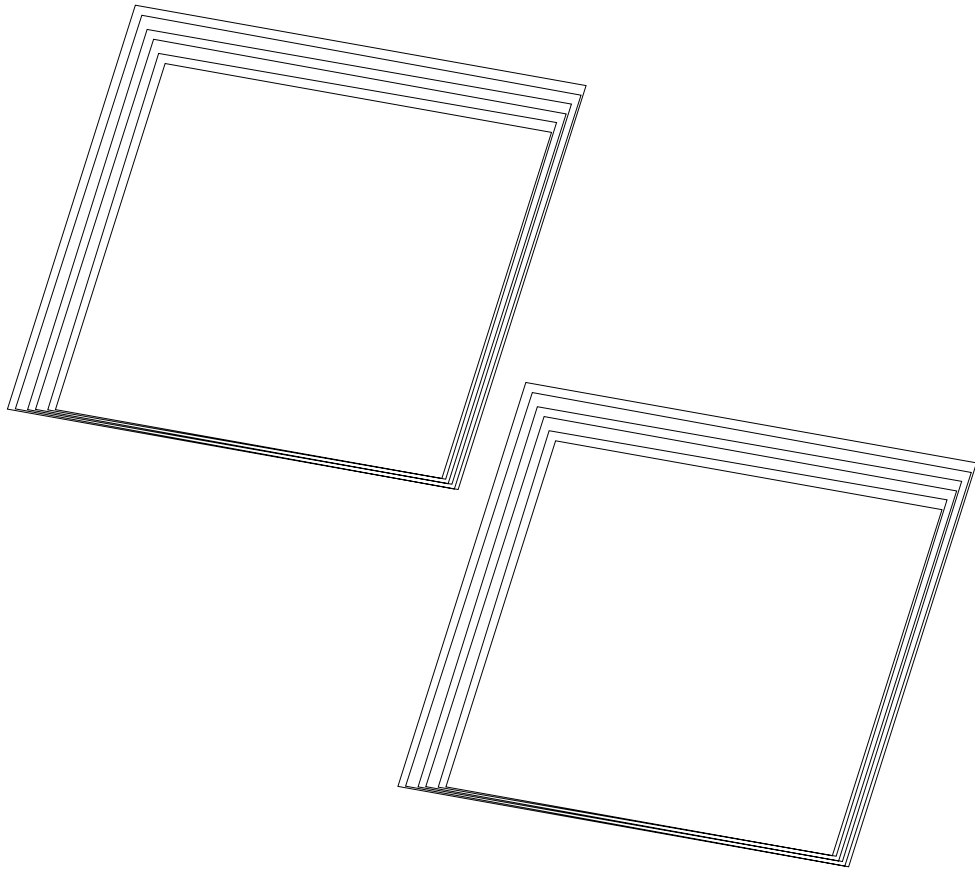

TIME: 5

<111> masks merge

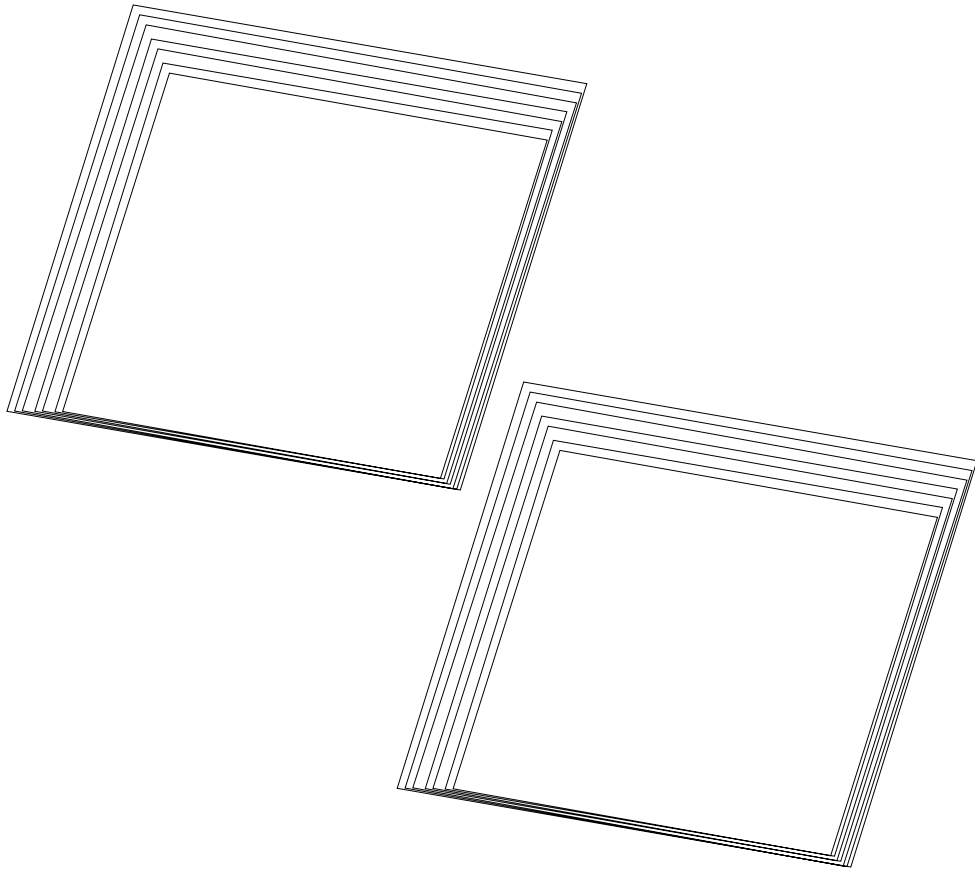

TIME: 6

<111> masks merge

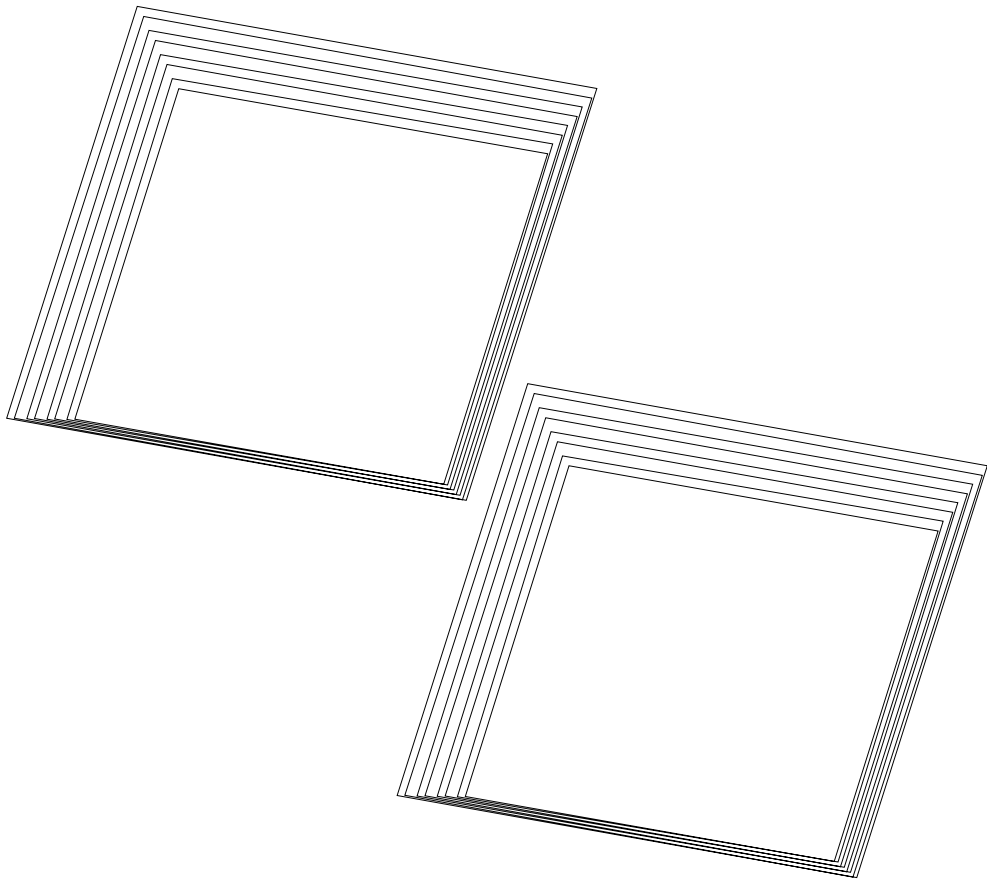

TIME: 7

<111> masks merge

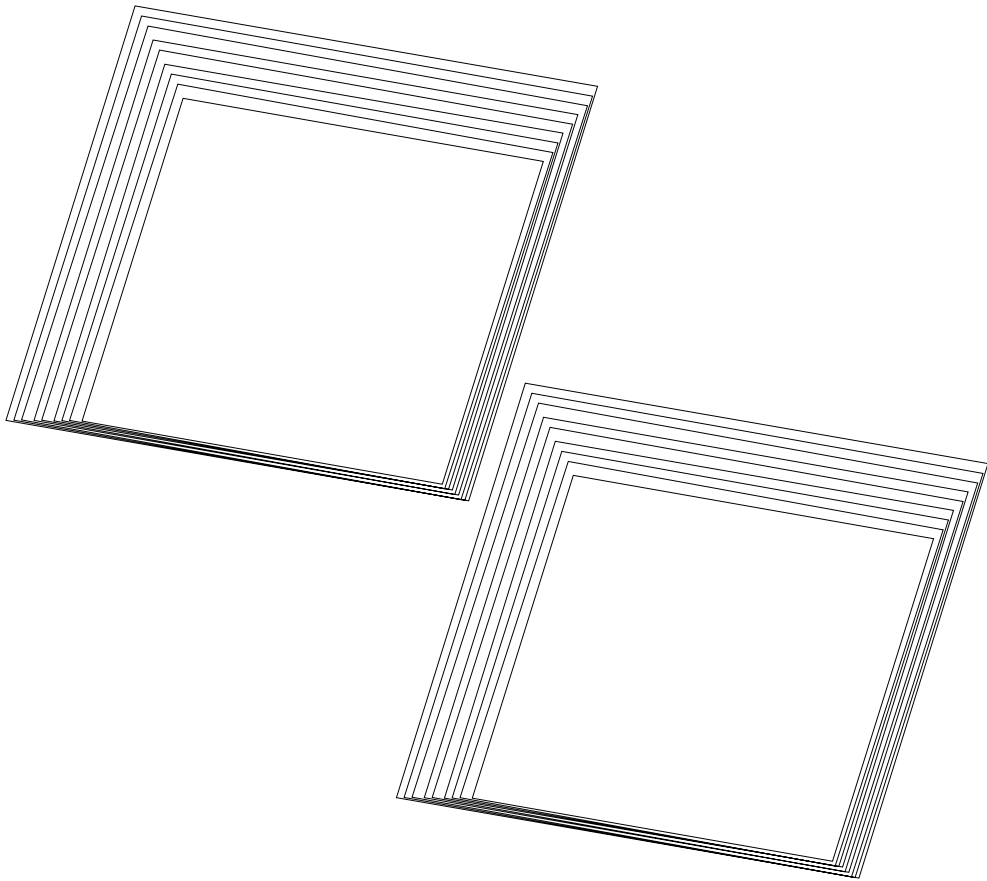

TIME: 8

<111> masks merge

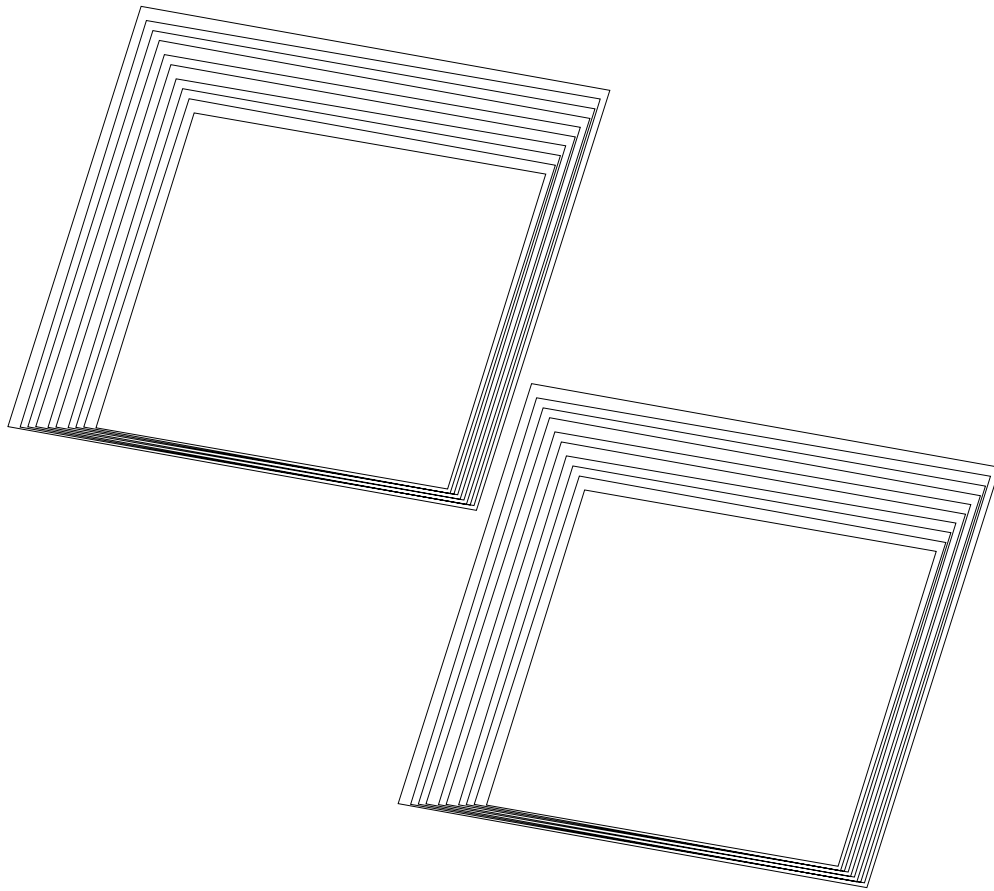

TIME: 9

<111> masks merge

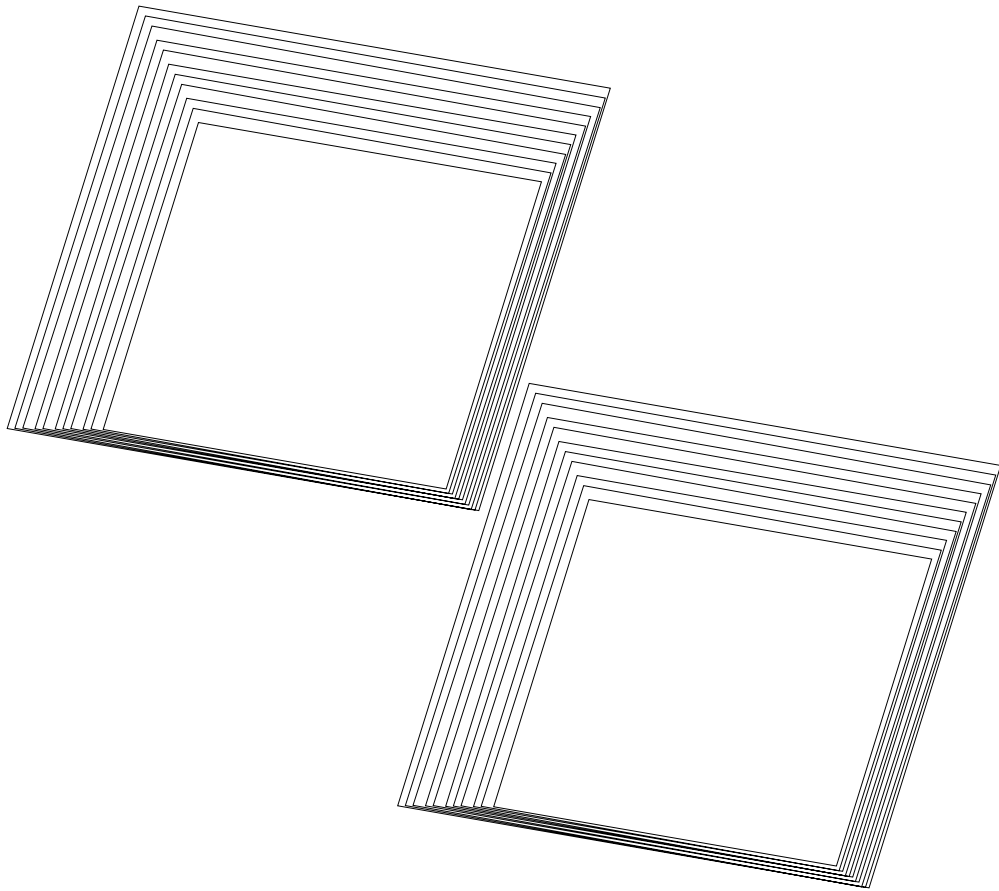

TIME: 10

<111> masks merge

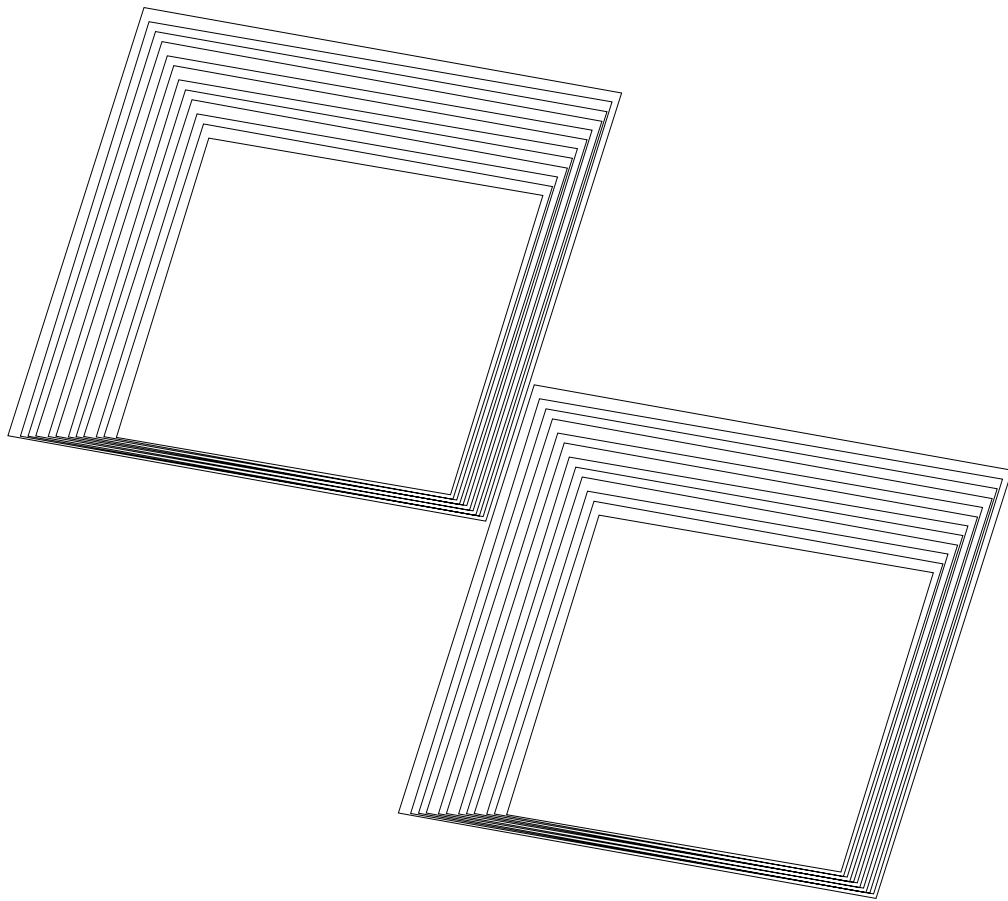

TIME: 11

<111> masks merge

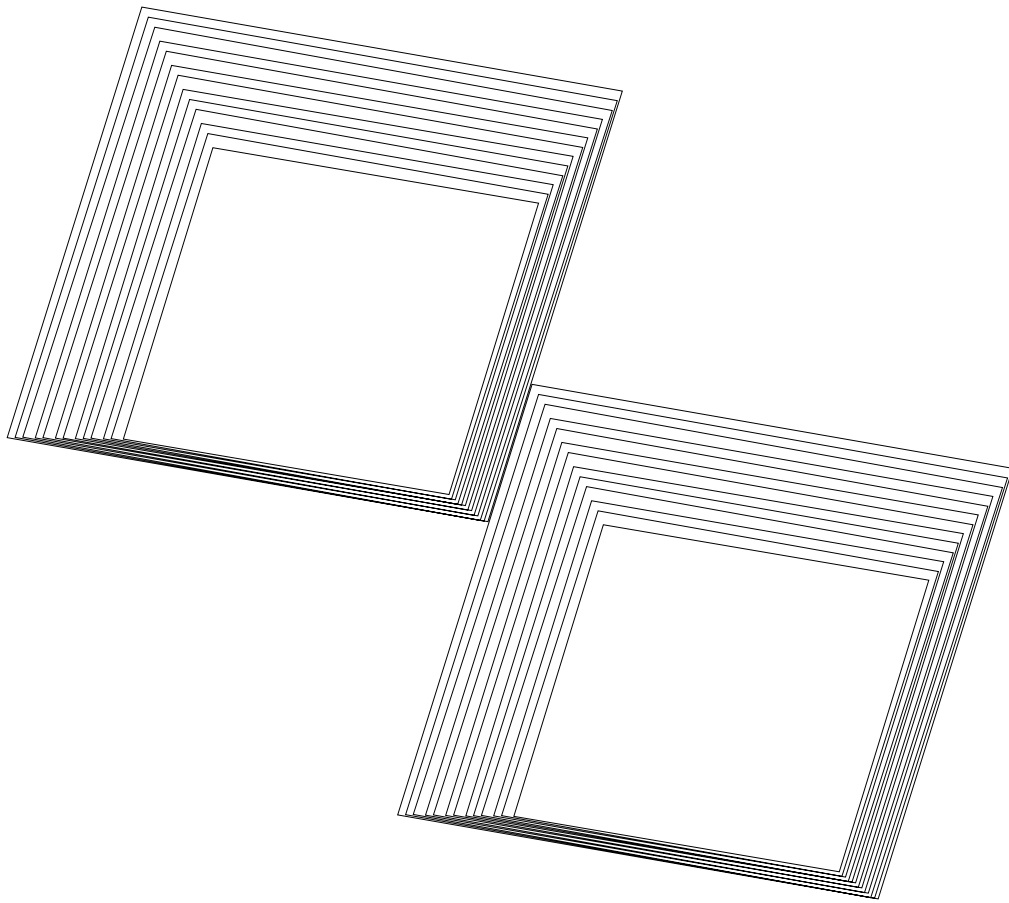

TIME: 12

<111> masks merge

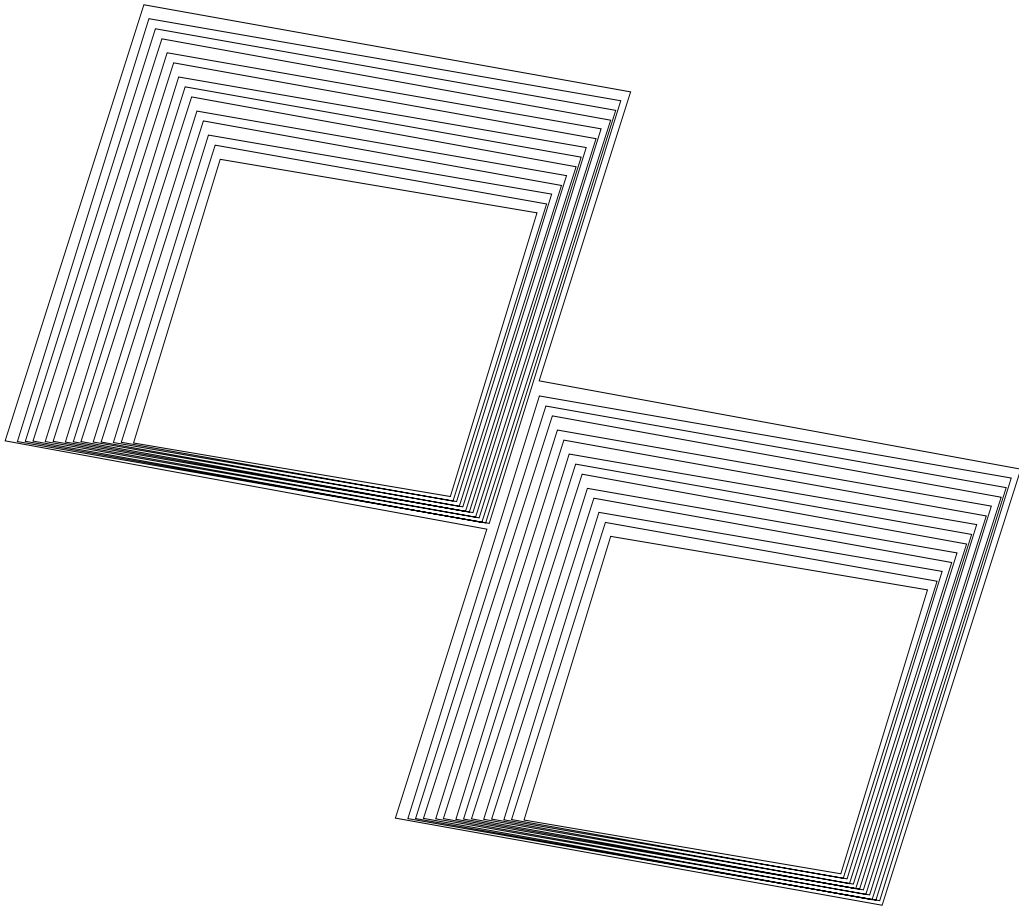

TIME: 13

<111> masks merge

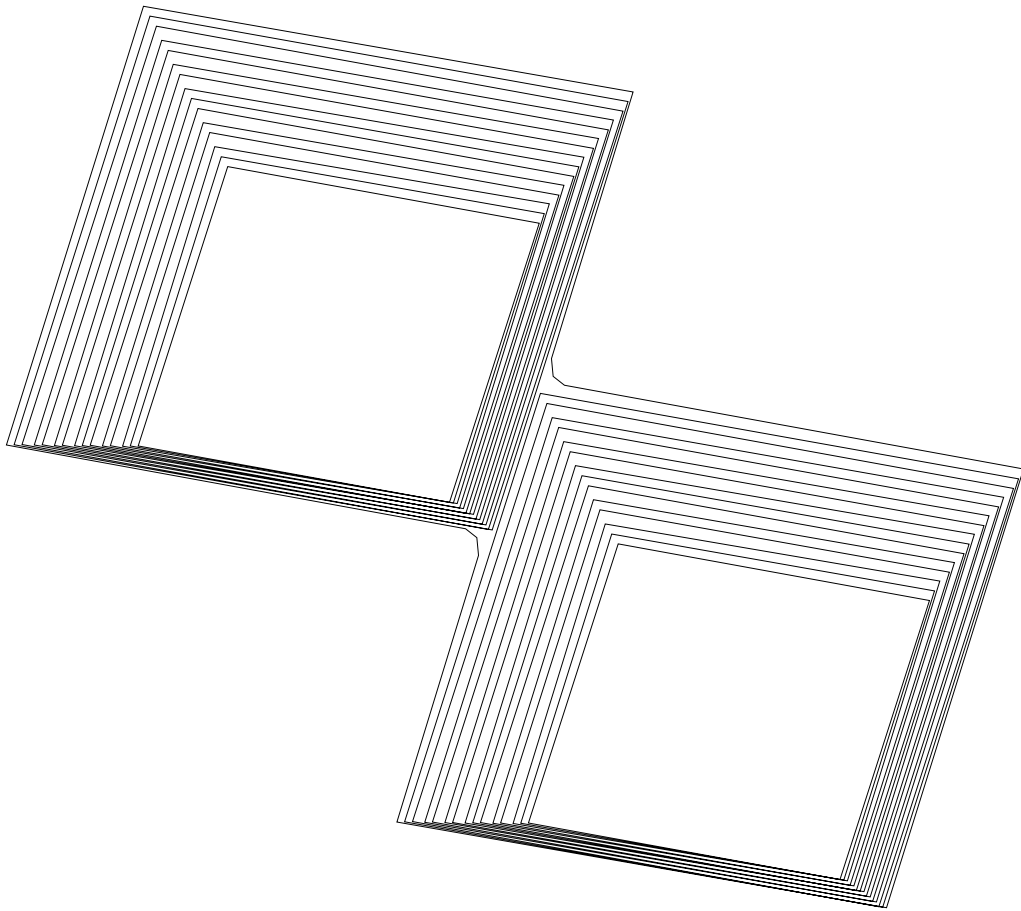

TIME: 14

<111> masks merge

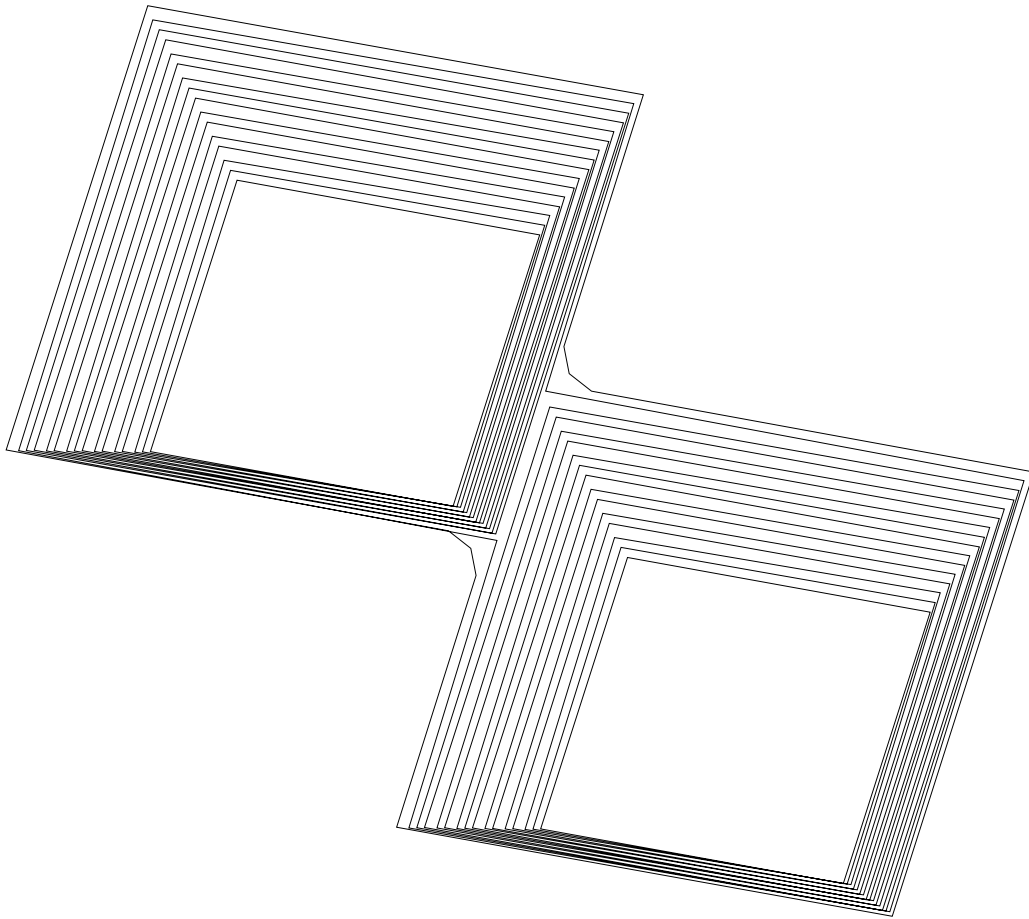

TIME: 15

<111> masks merge

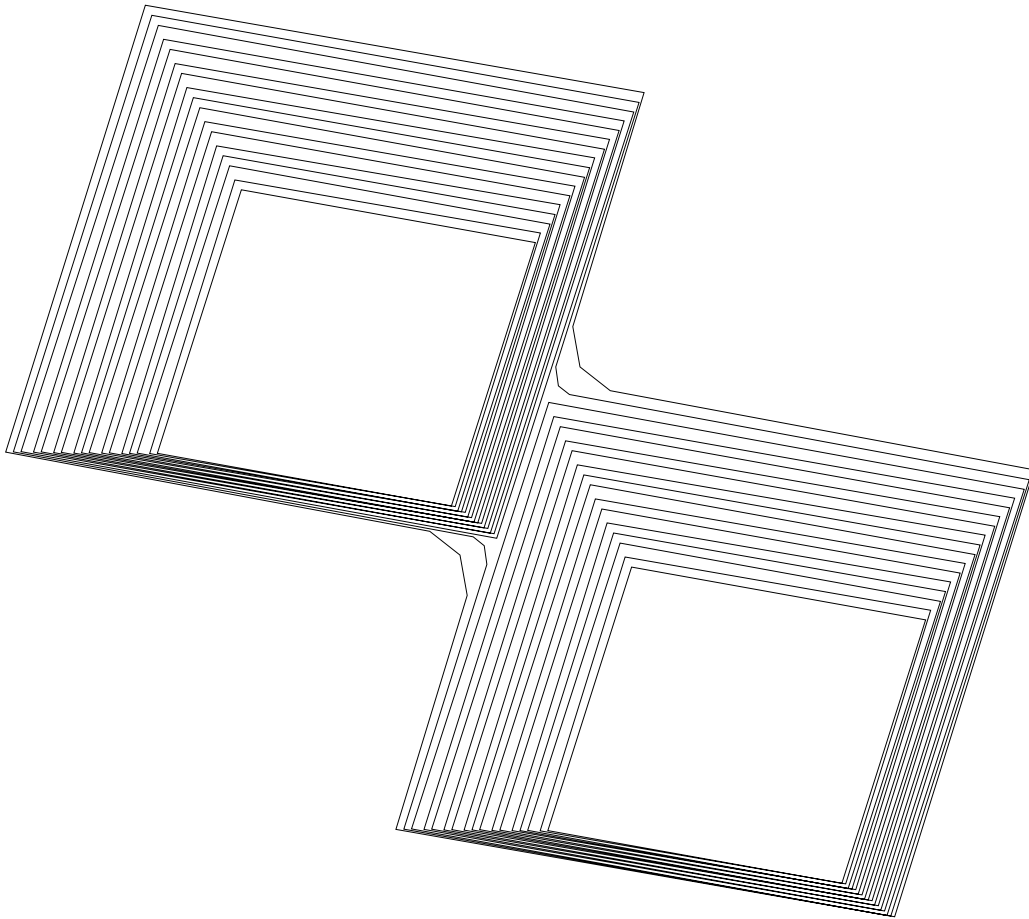

TIME: 16

<111> masks merge

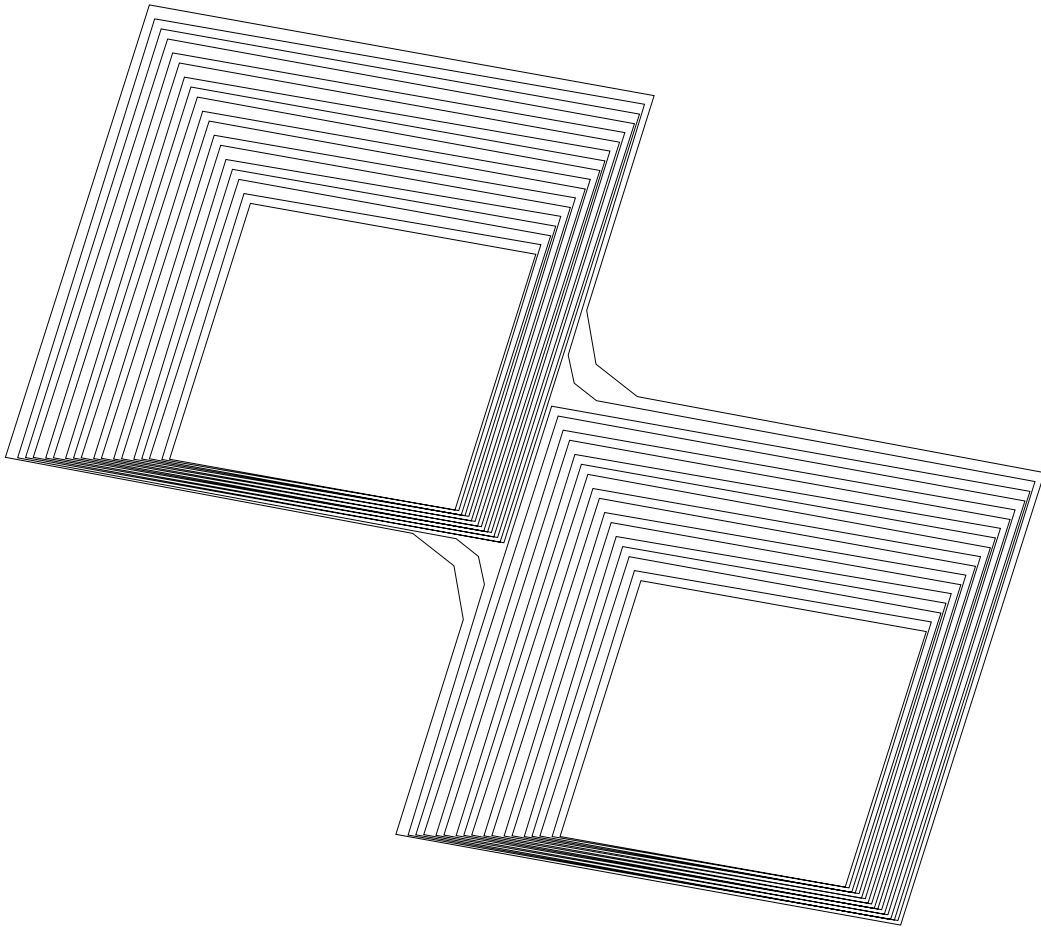

TIME: 17

<111> masks merge

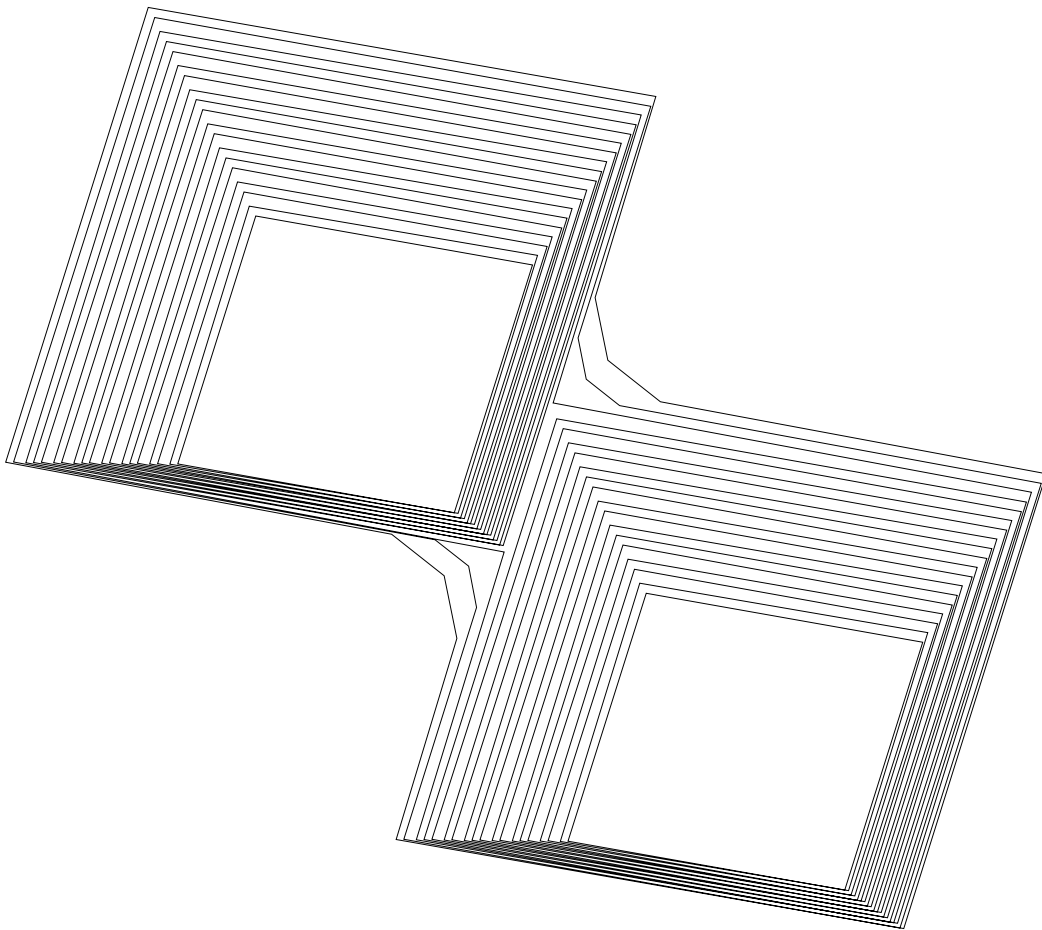

TIME: 18

<111> masks merge

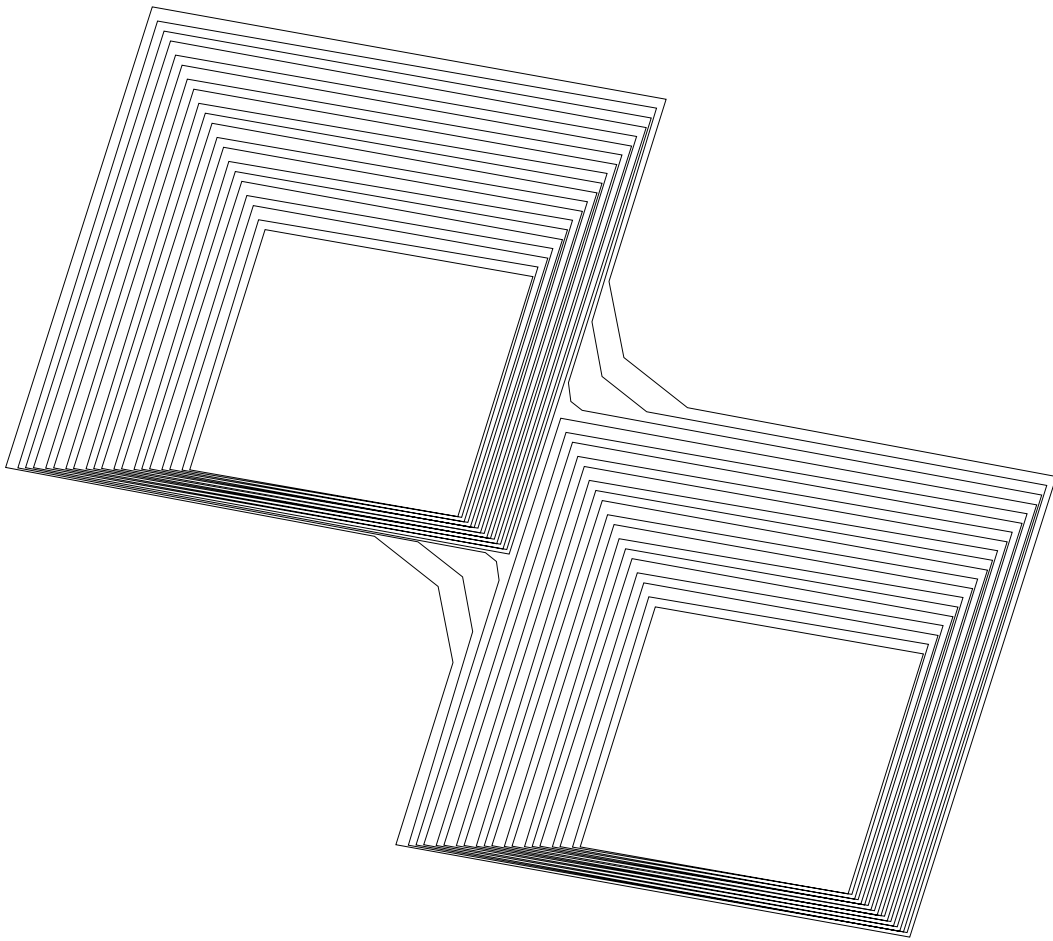

TIME: 19

<111> masks merge

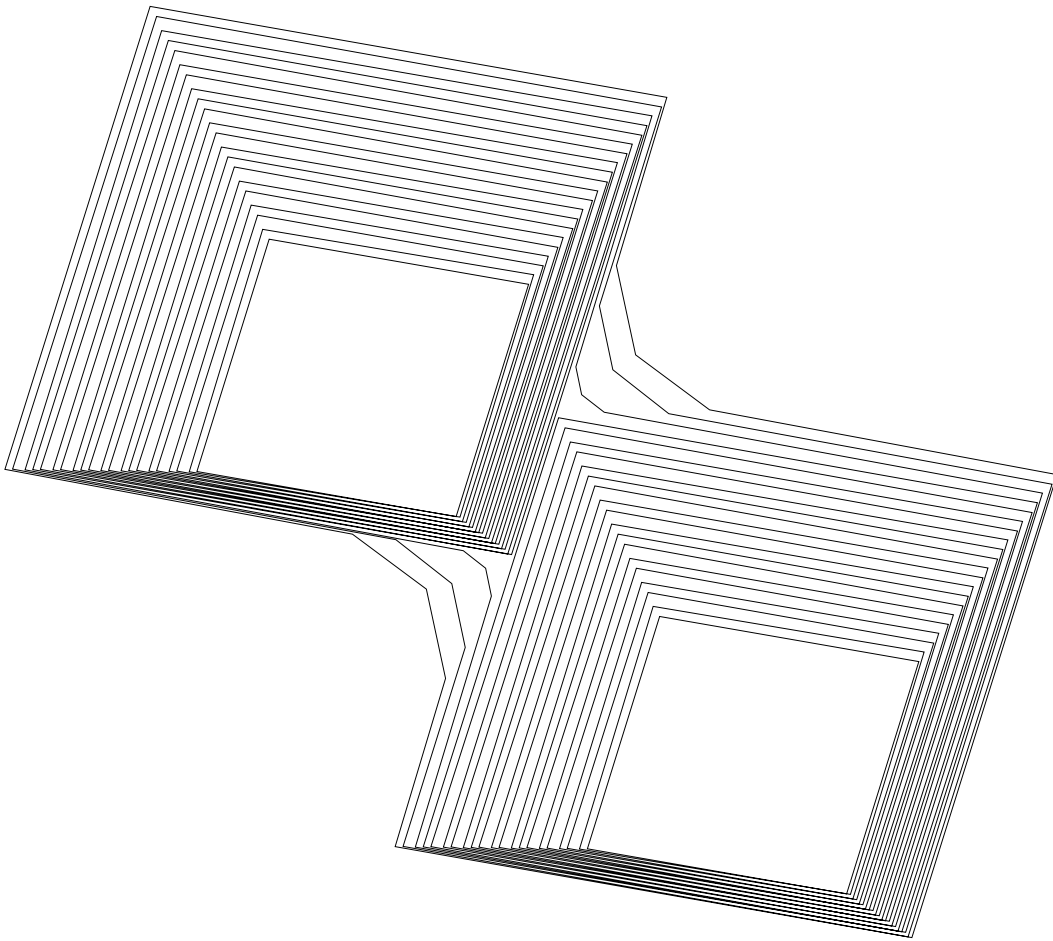

TIME: 20

<111> masks merge

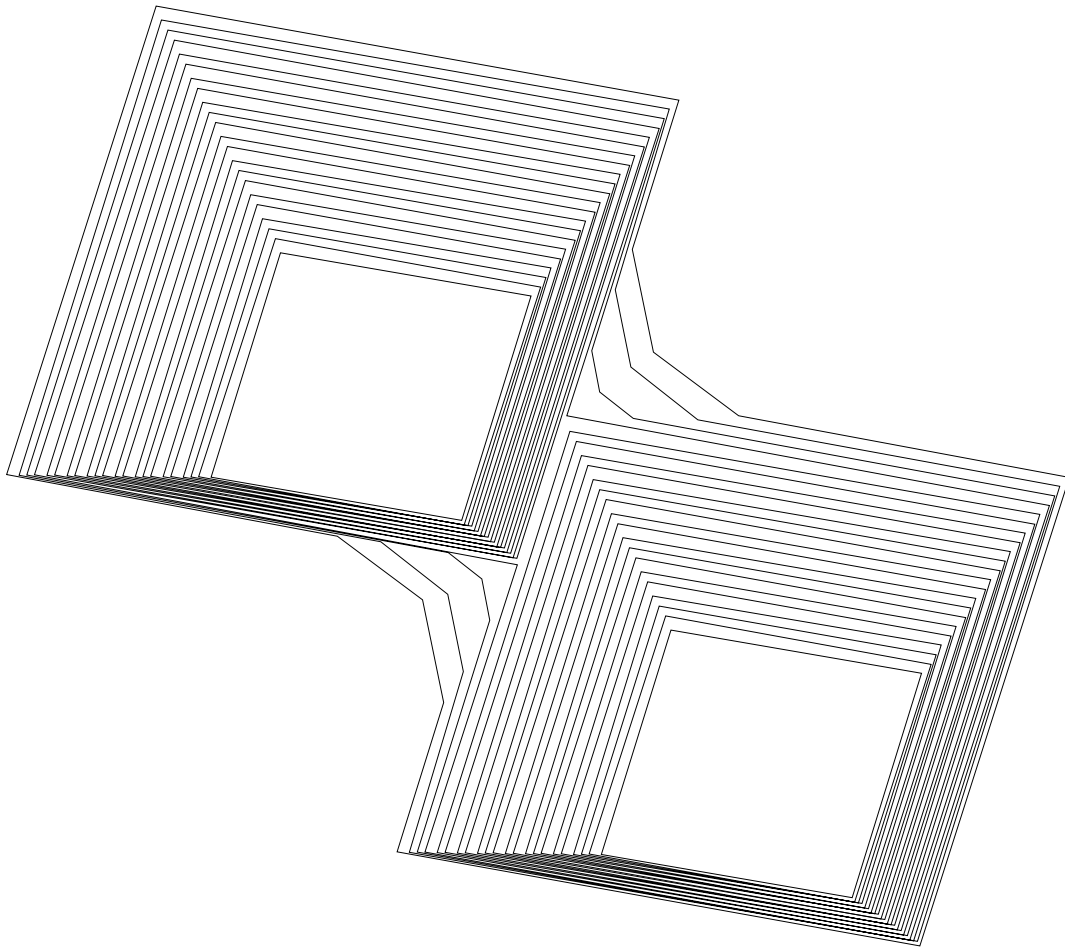

TIME: 21

<111> masks merge

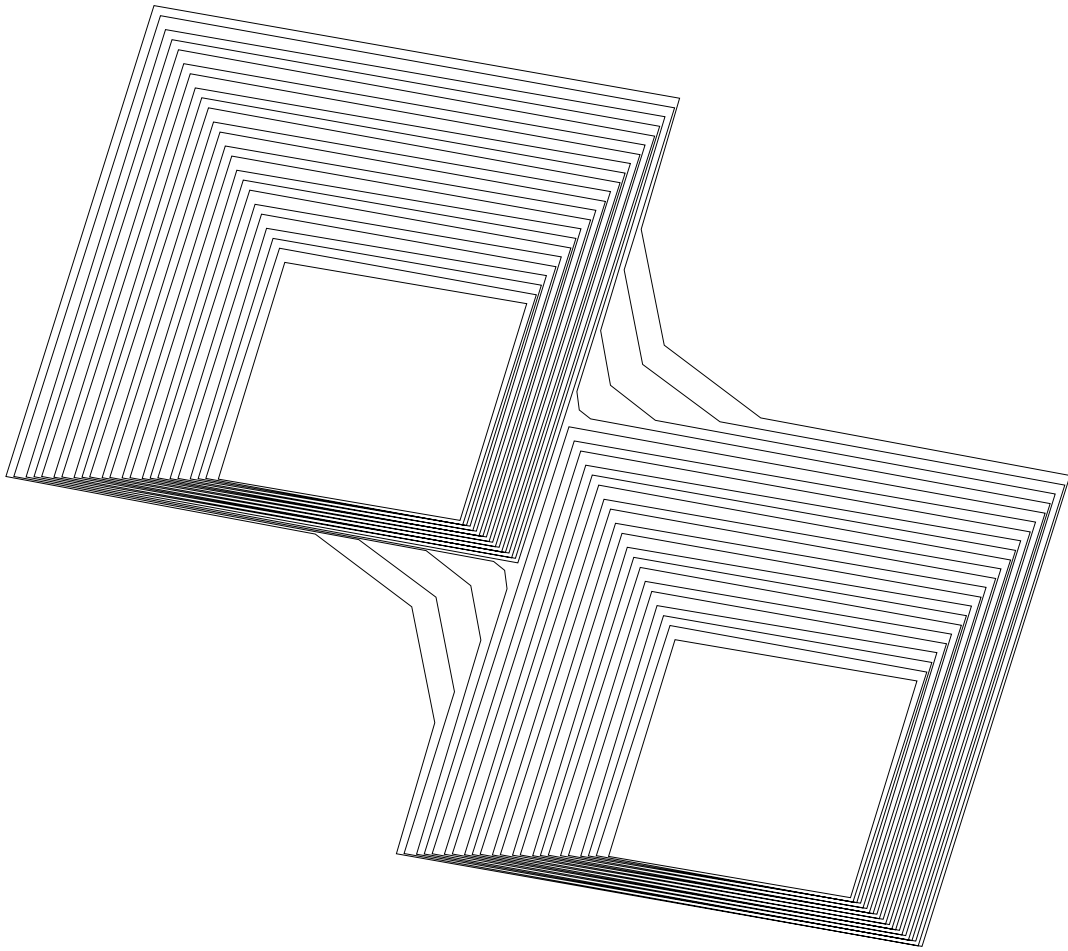

TIME: 22

<111> masks merge

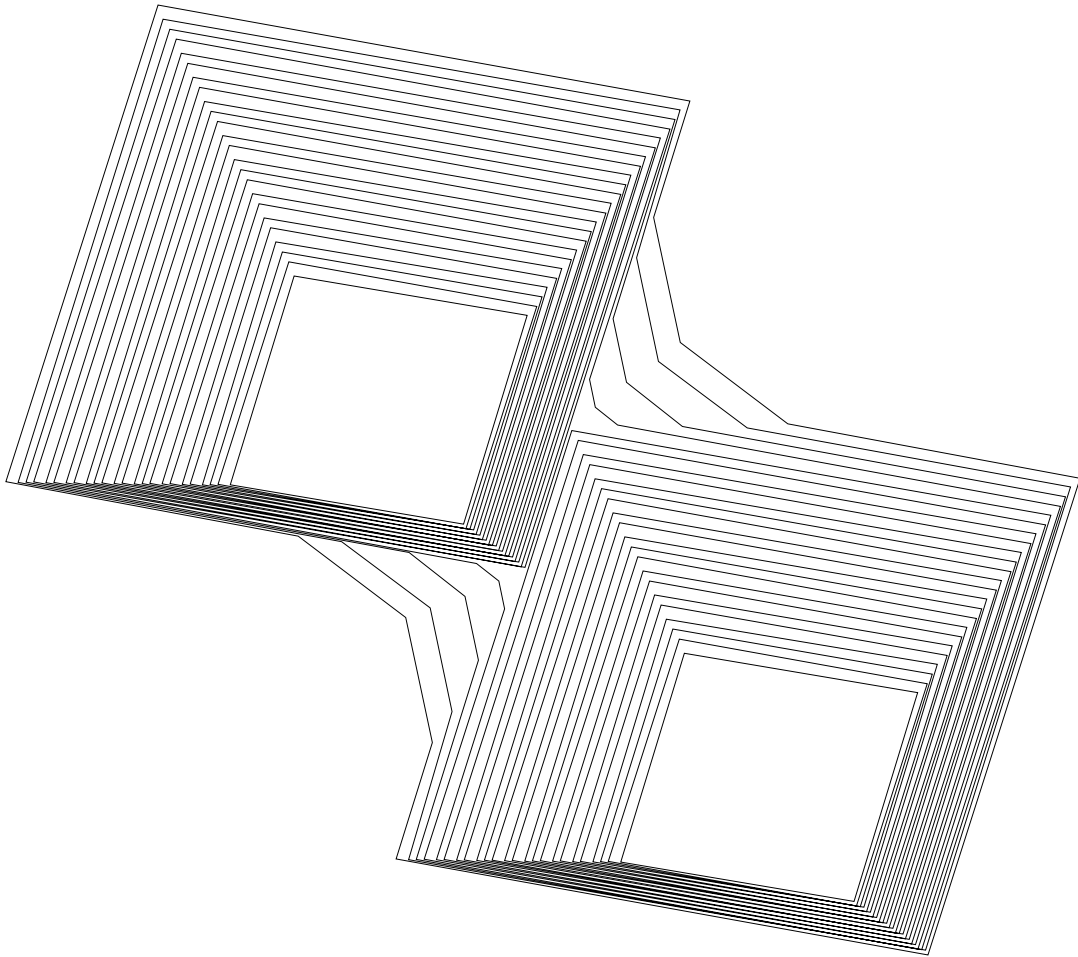

TIME: 23

<111> masks merge

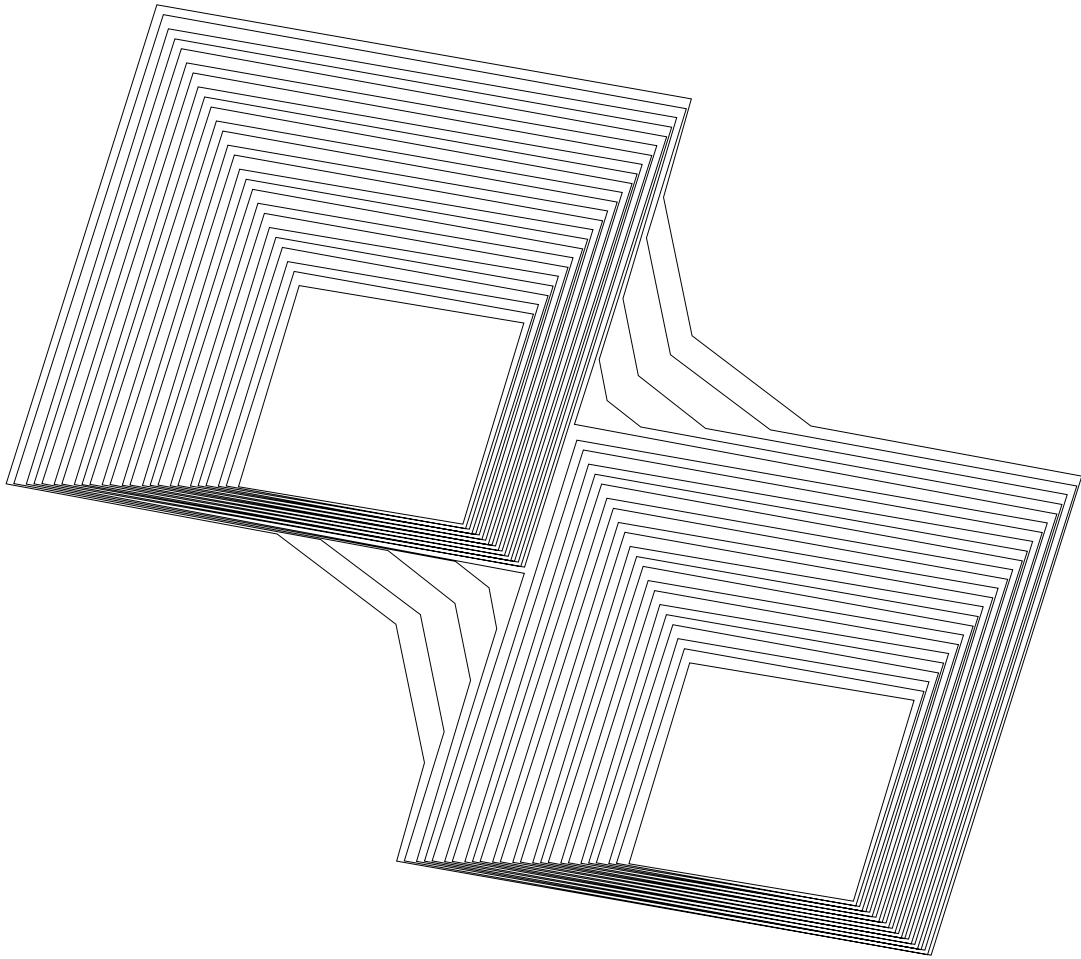

TIME: 24

<111> masks merge

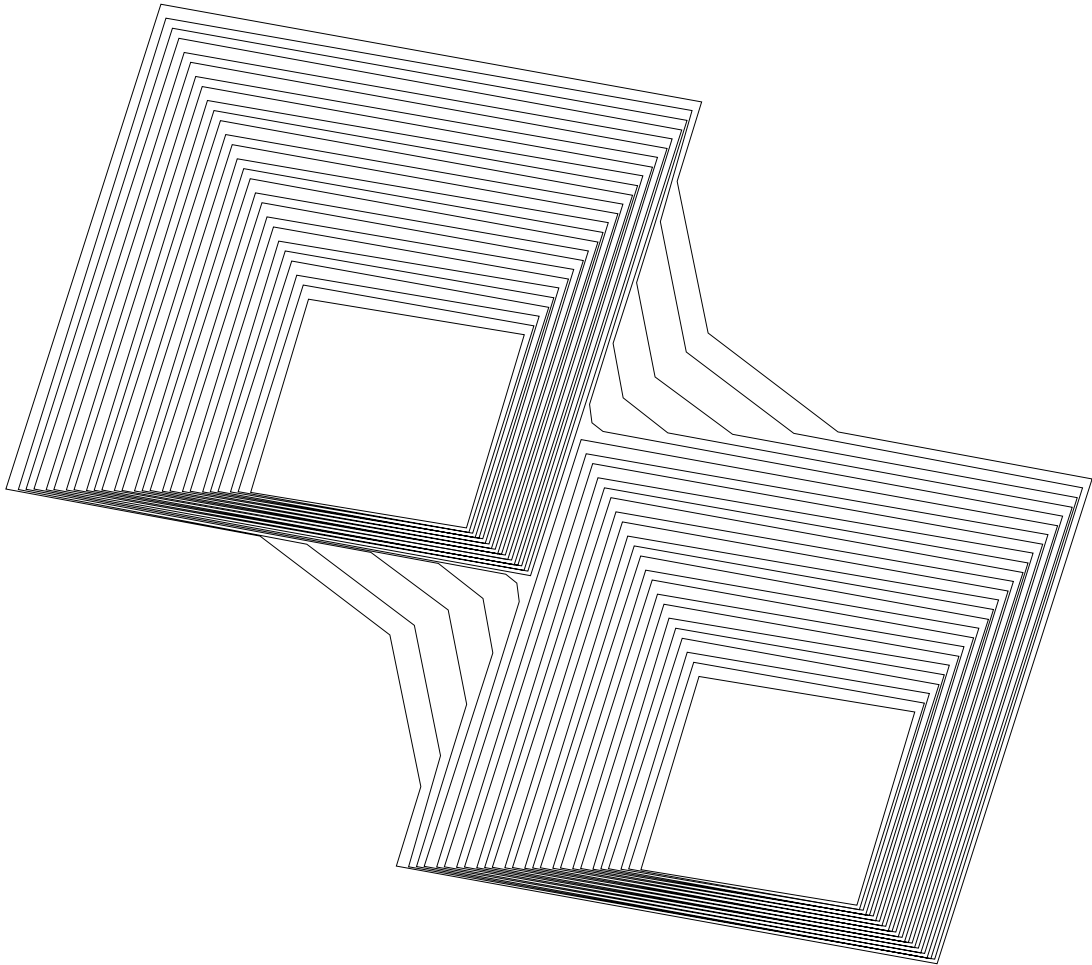

TIME: 25

<111> masks merge

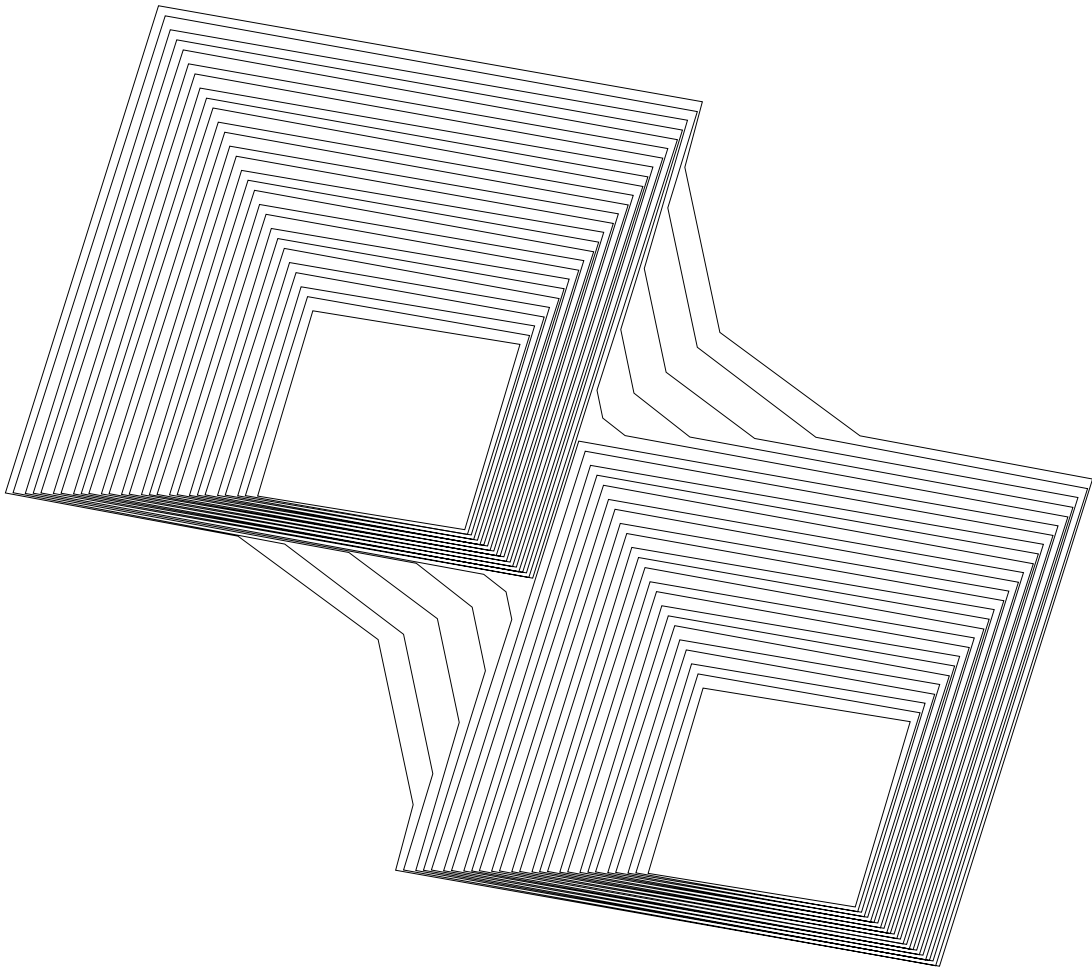

TIME: 26

<111> masks merge

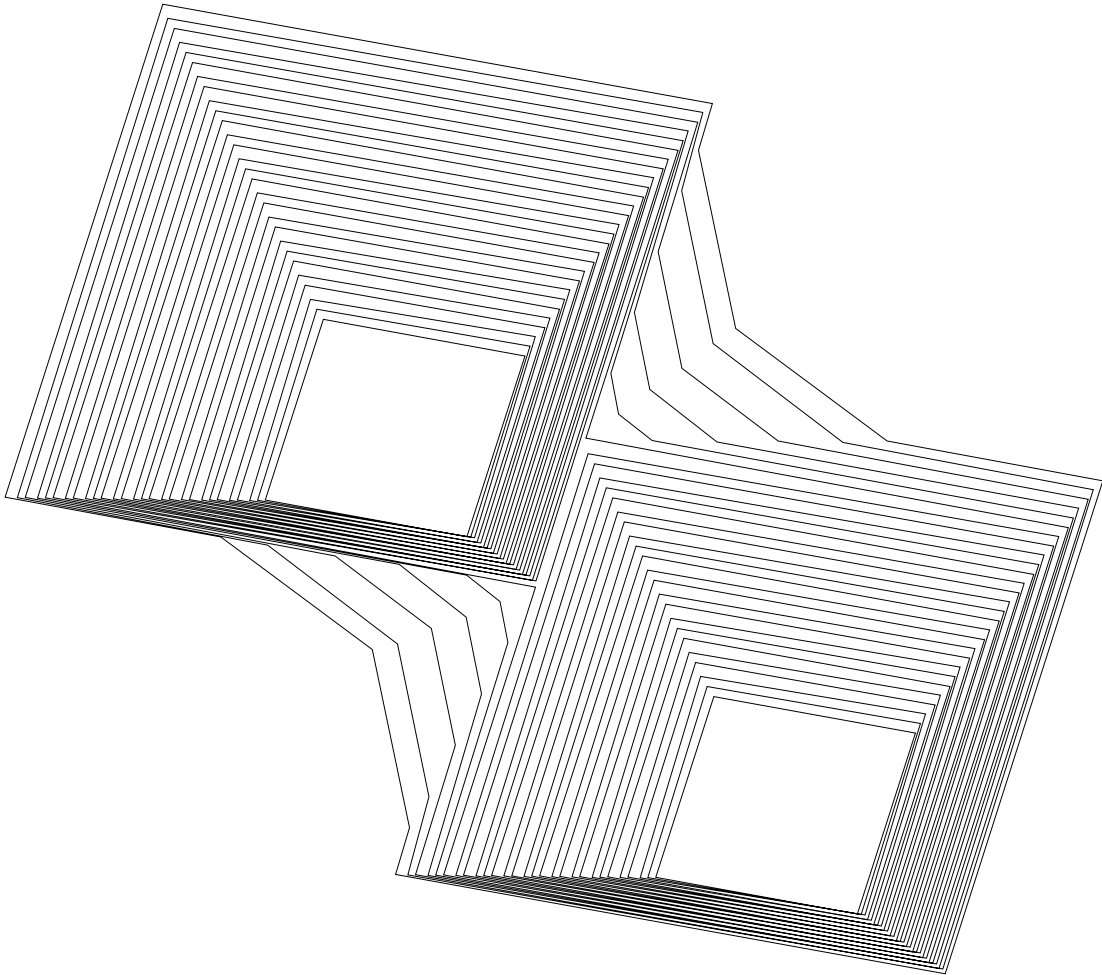

TIME: 27

<111> masks merge

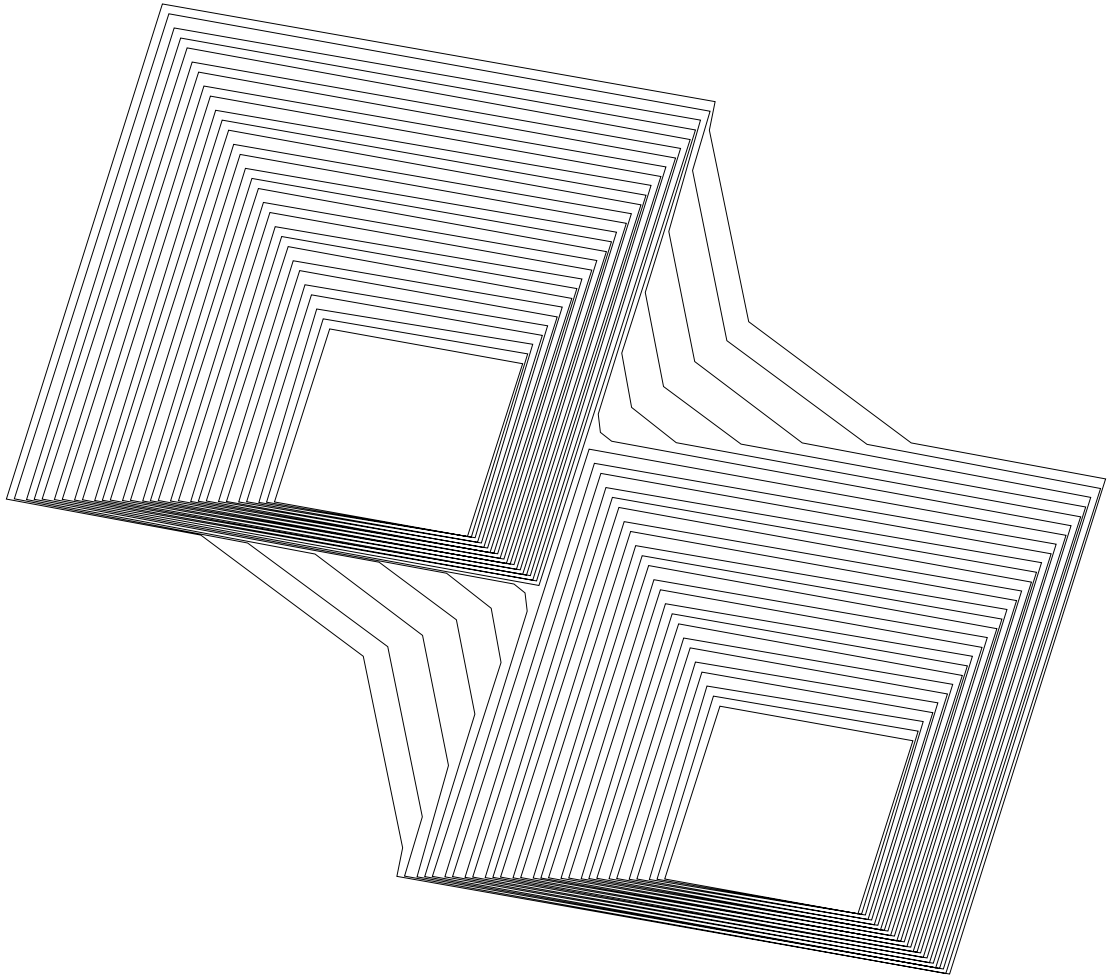

TIME: 28

<111> masks merge

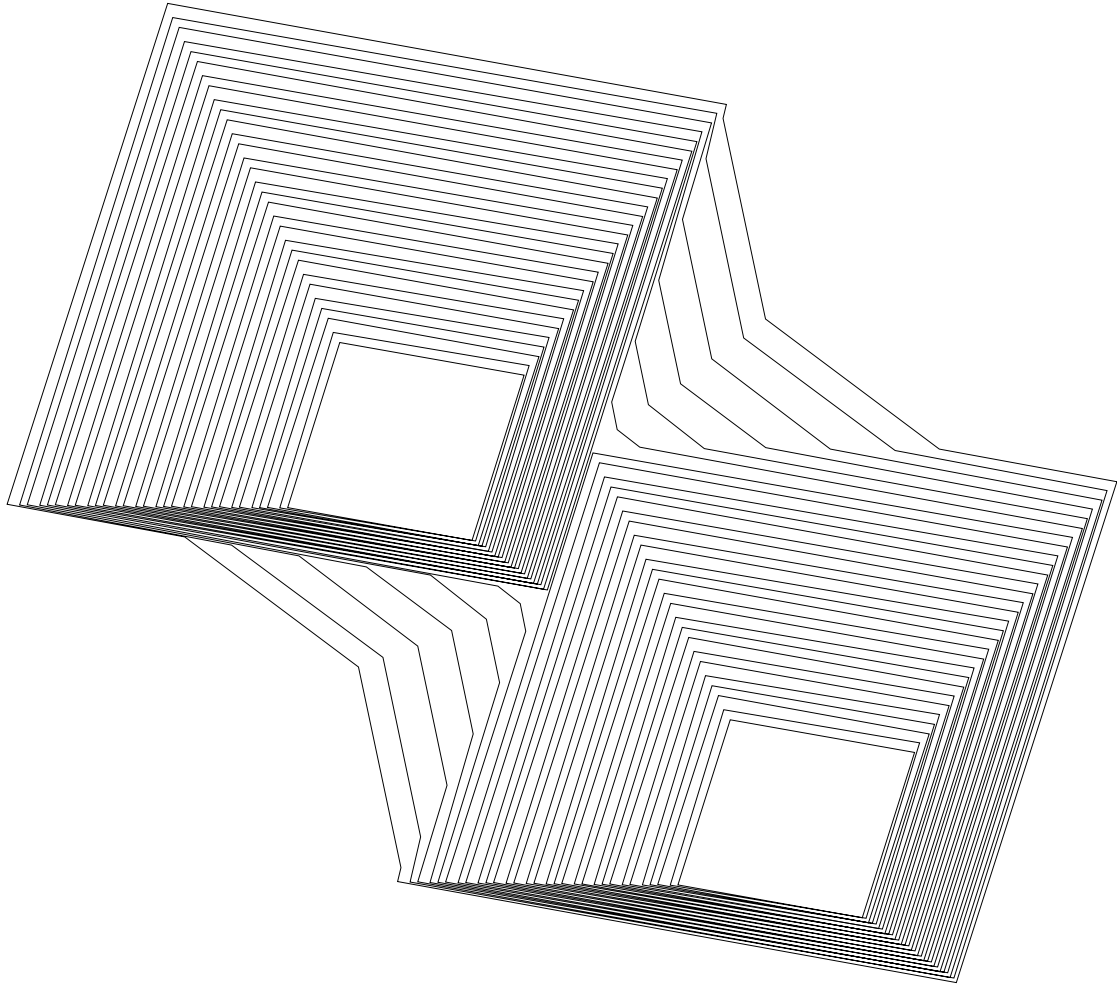

TIME: 29

<111> masks merge

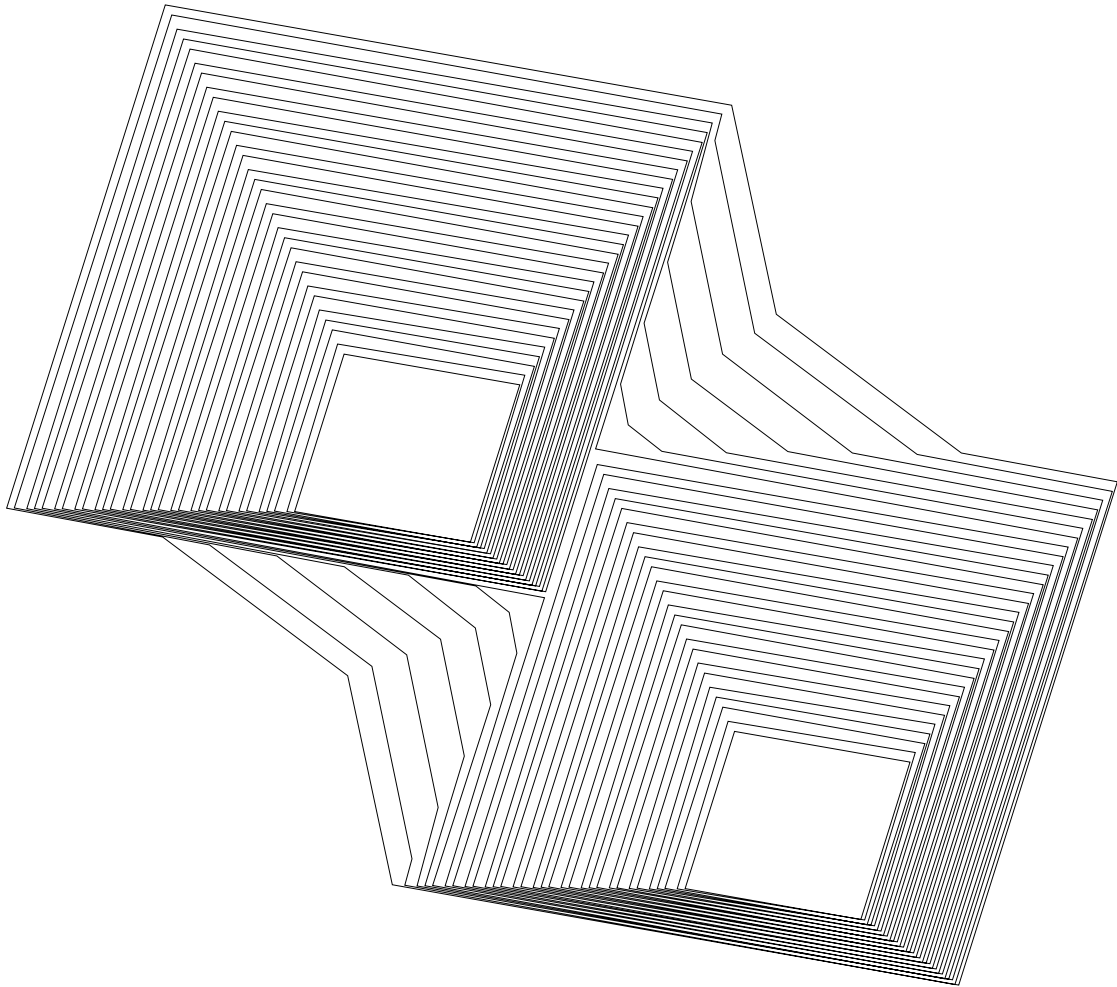

TIME: 30

<111> masks merge

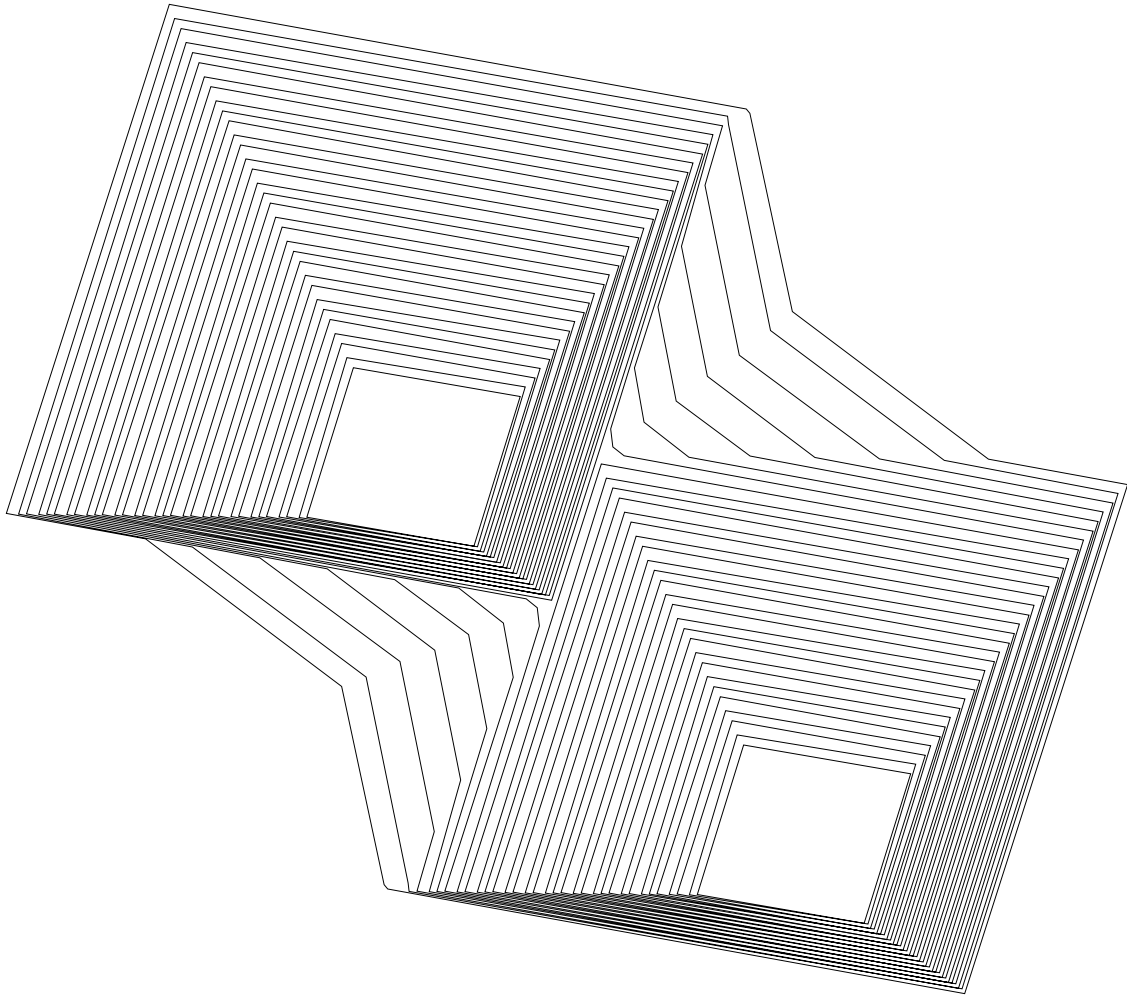

TIME: 31

<111> masks merge

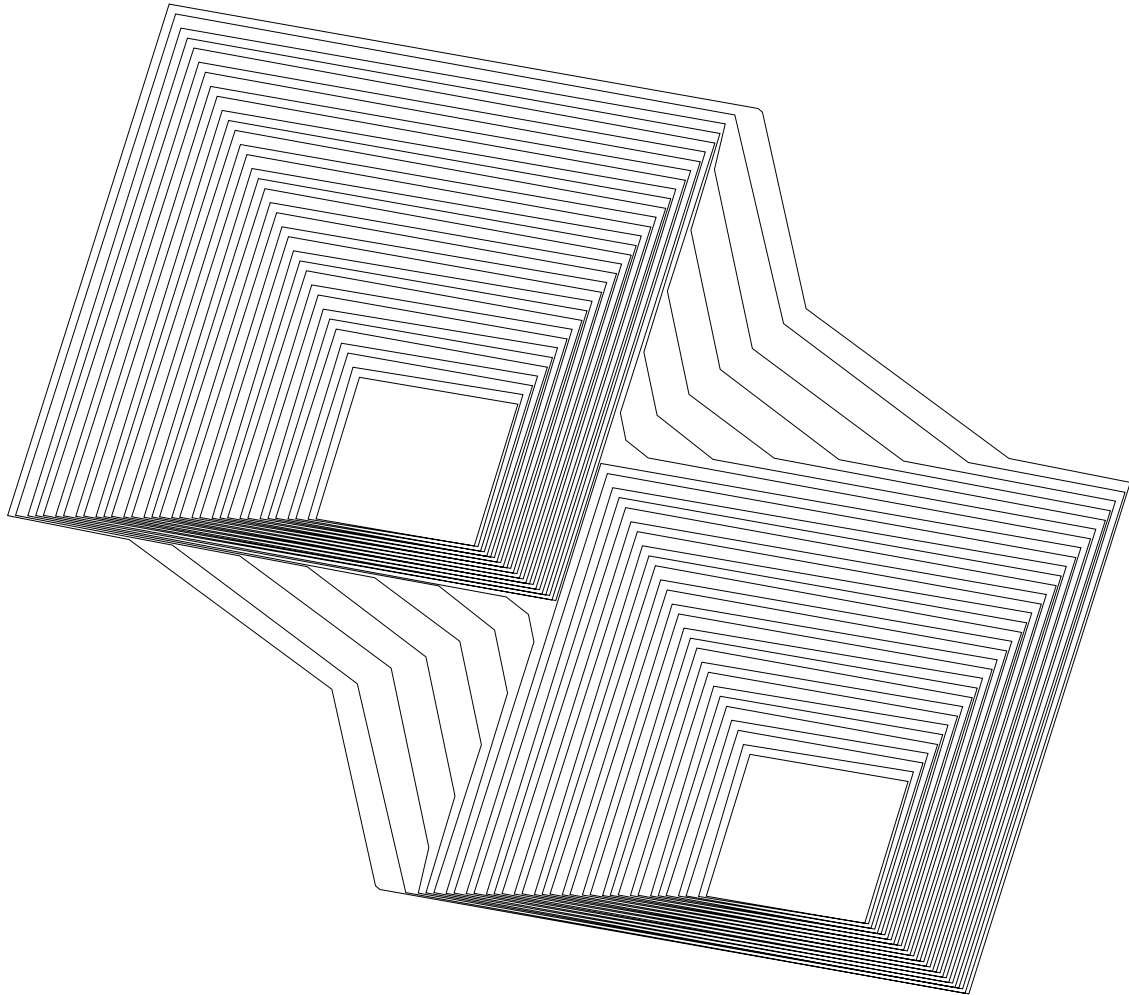

TIME: 32

<111> masks merge

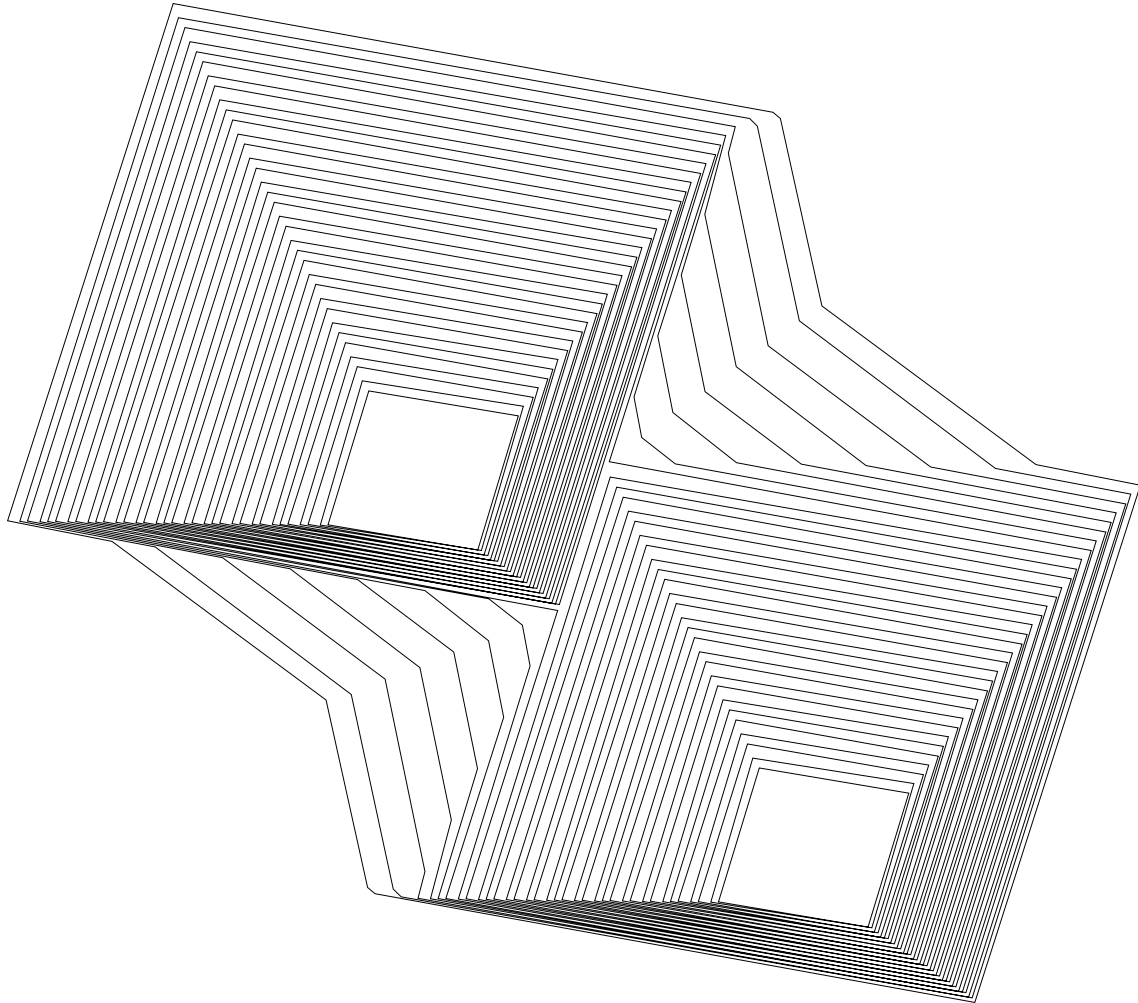

TIME: 33

<111> masks merge

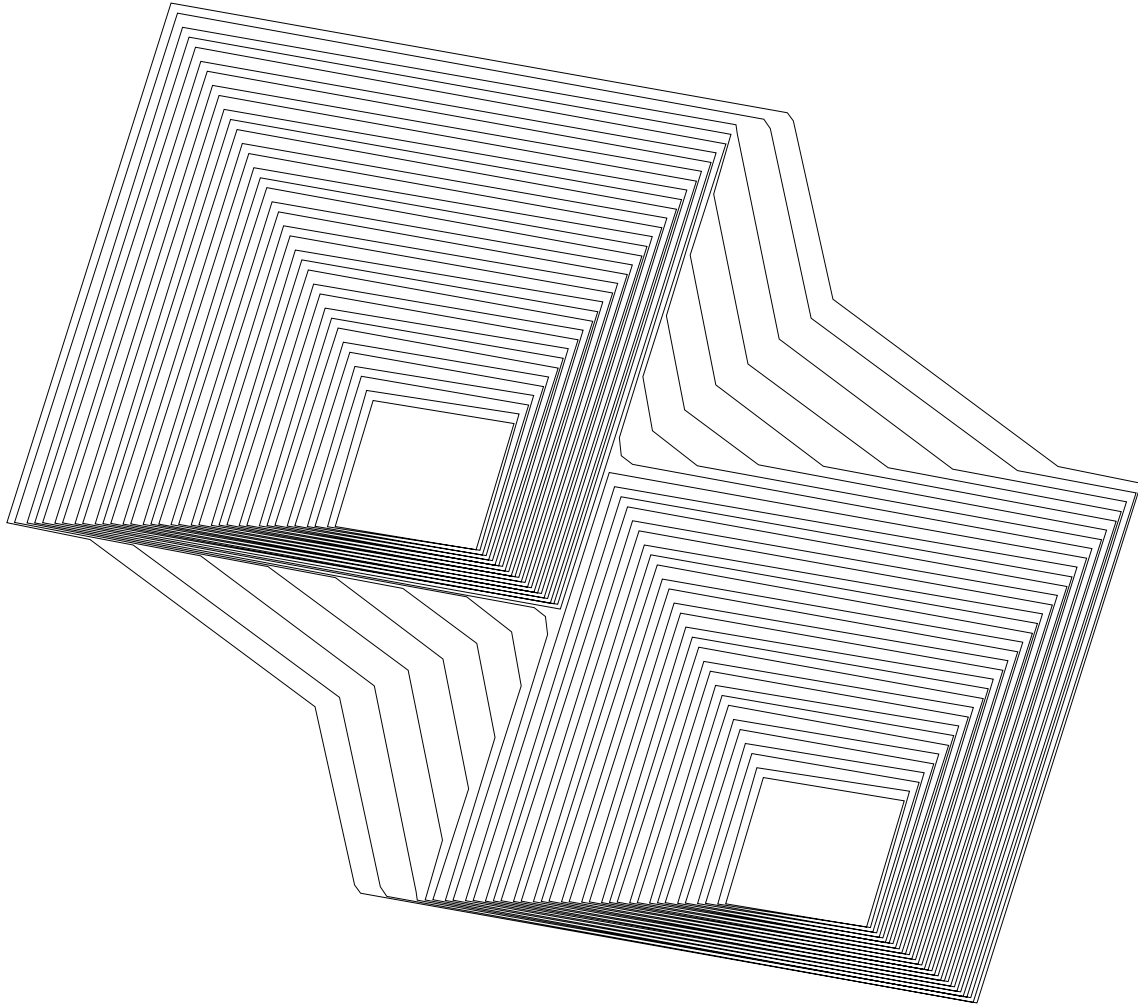

TIME: 34

<111> masks merge

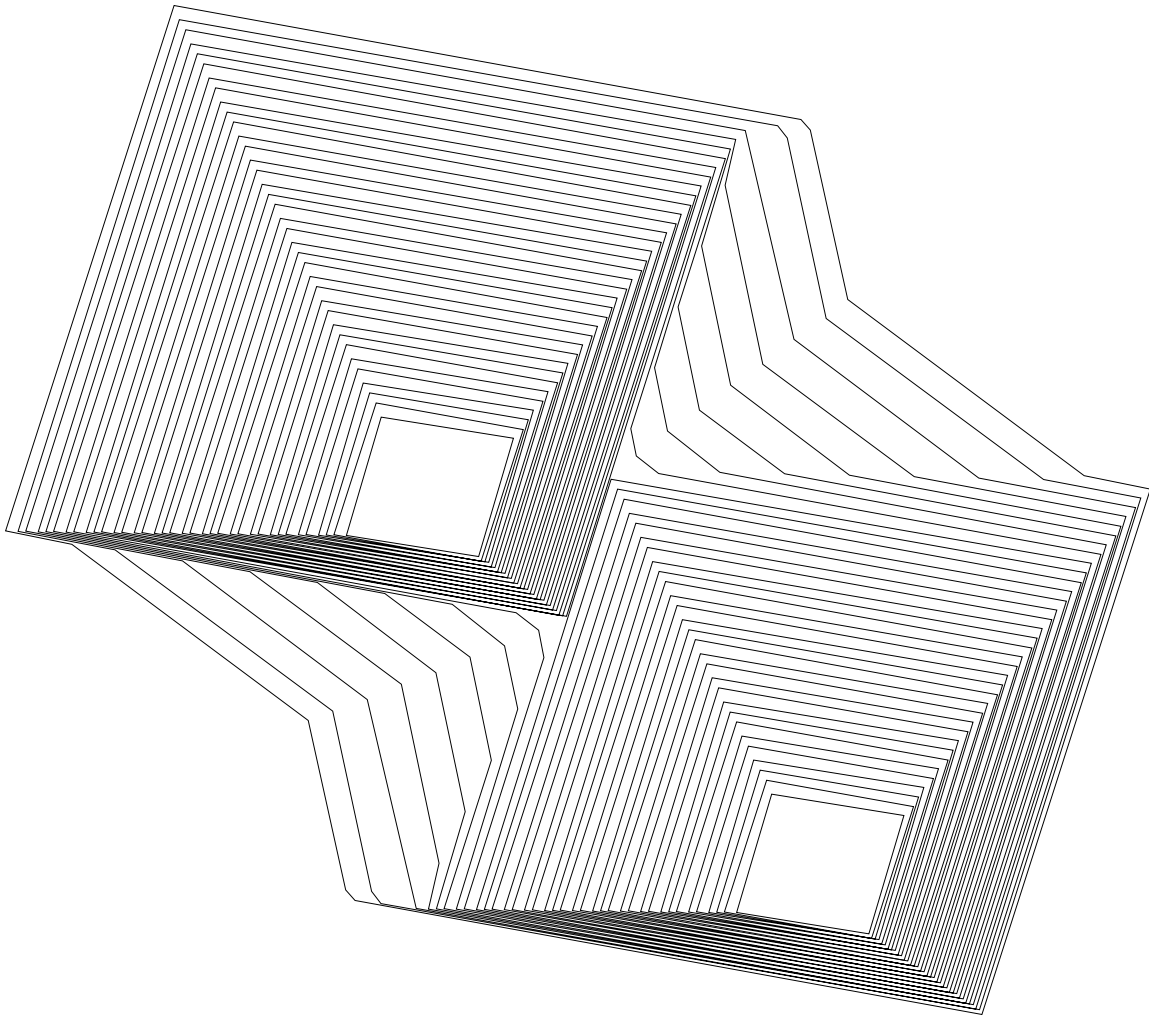

TIME: 35

<111> masks merge

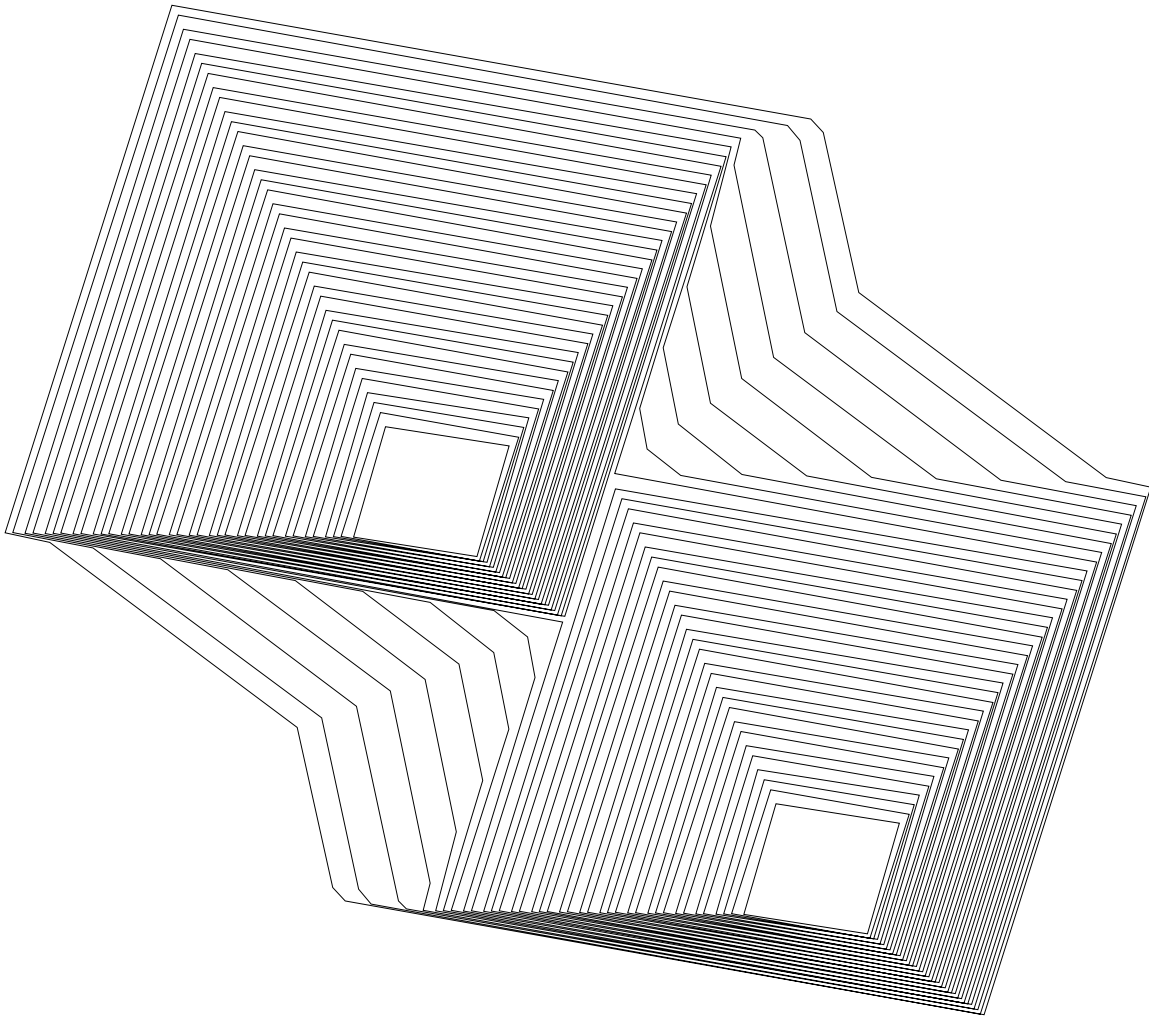

TIME: 36

<111> masks merge

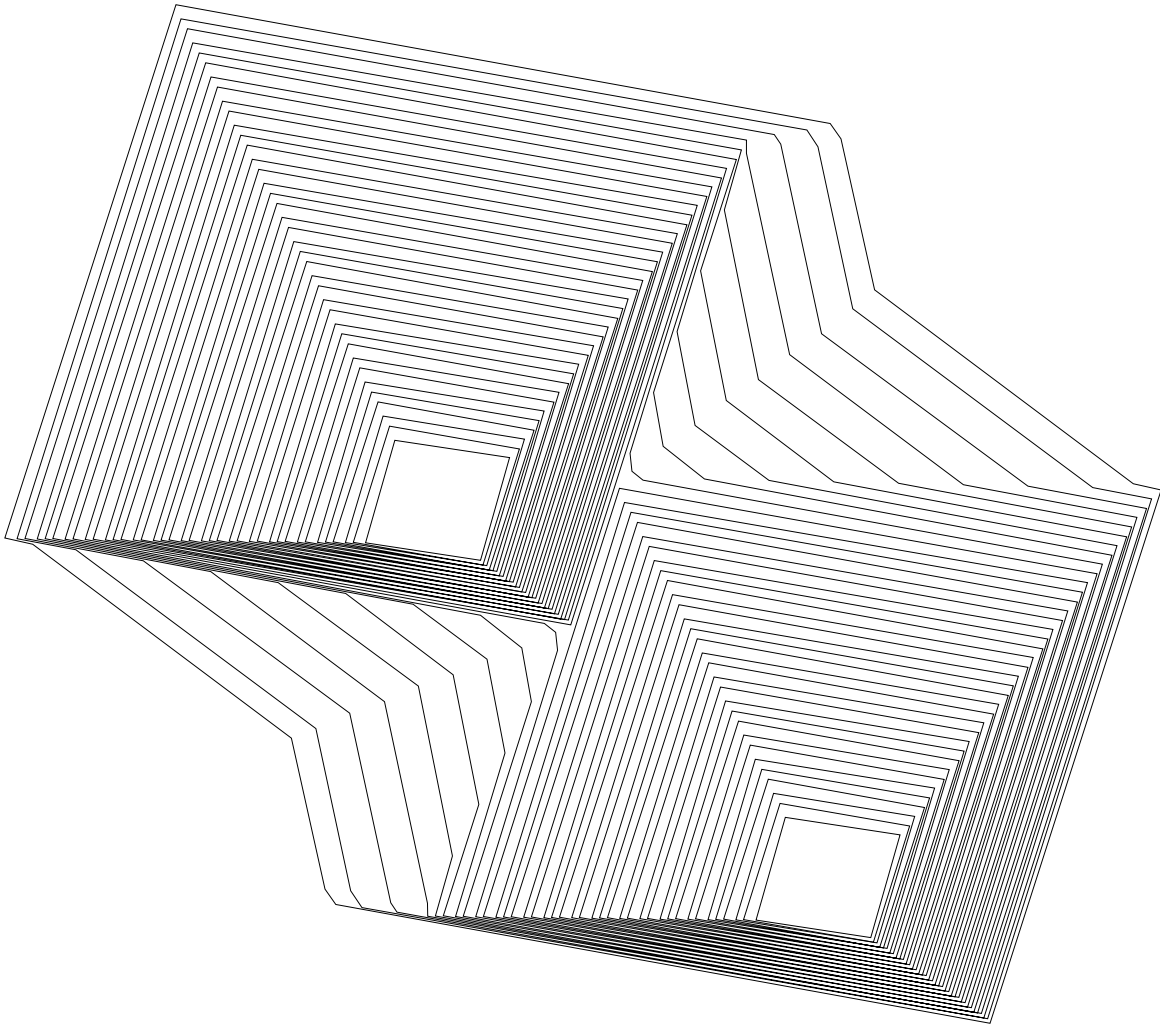

TIME: 37

<111> masks merge

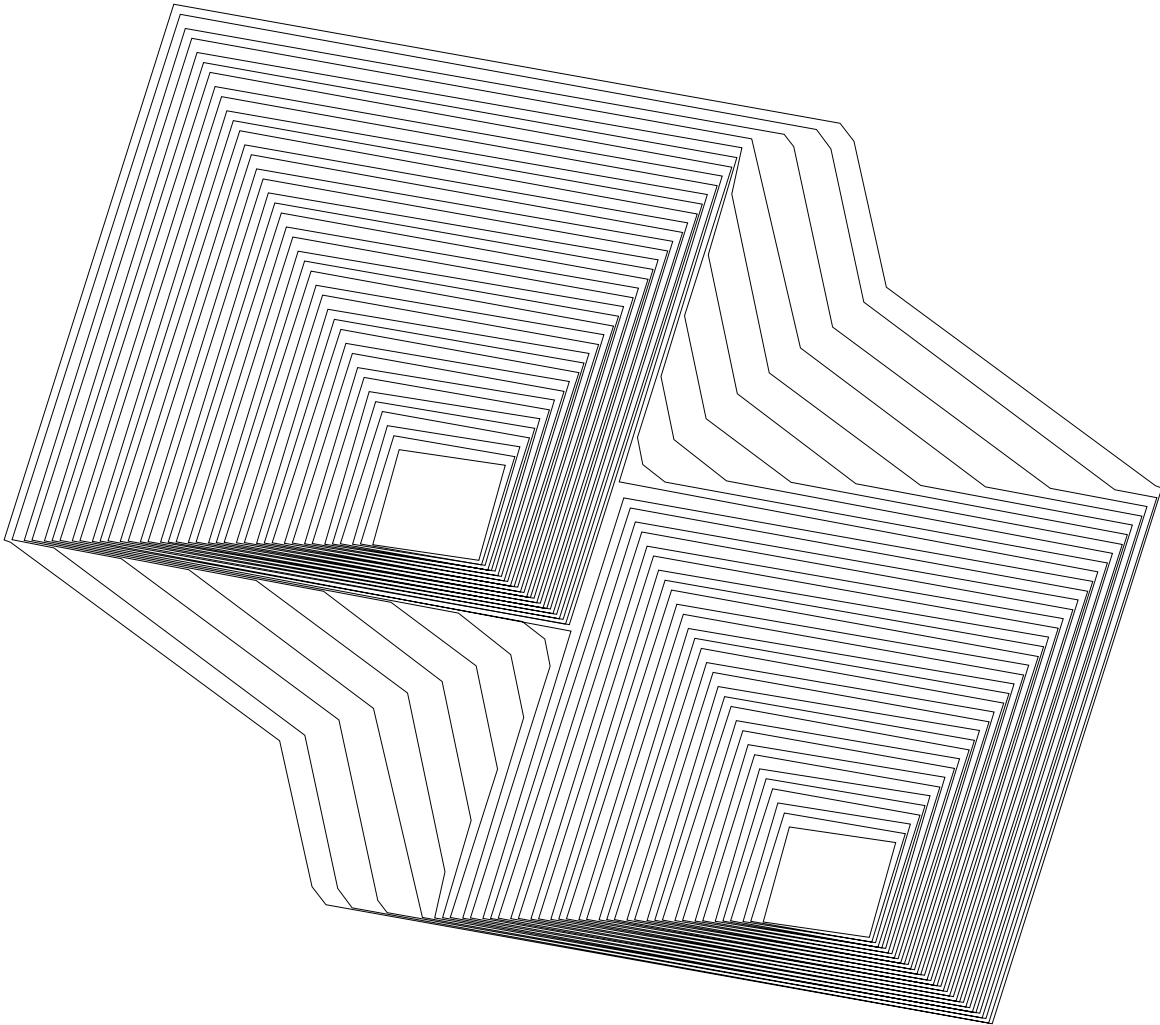

TIME: 38

$\langle 111 \rangle$  masks merge

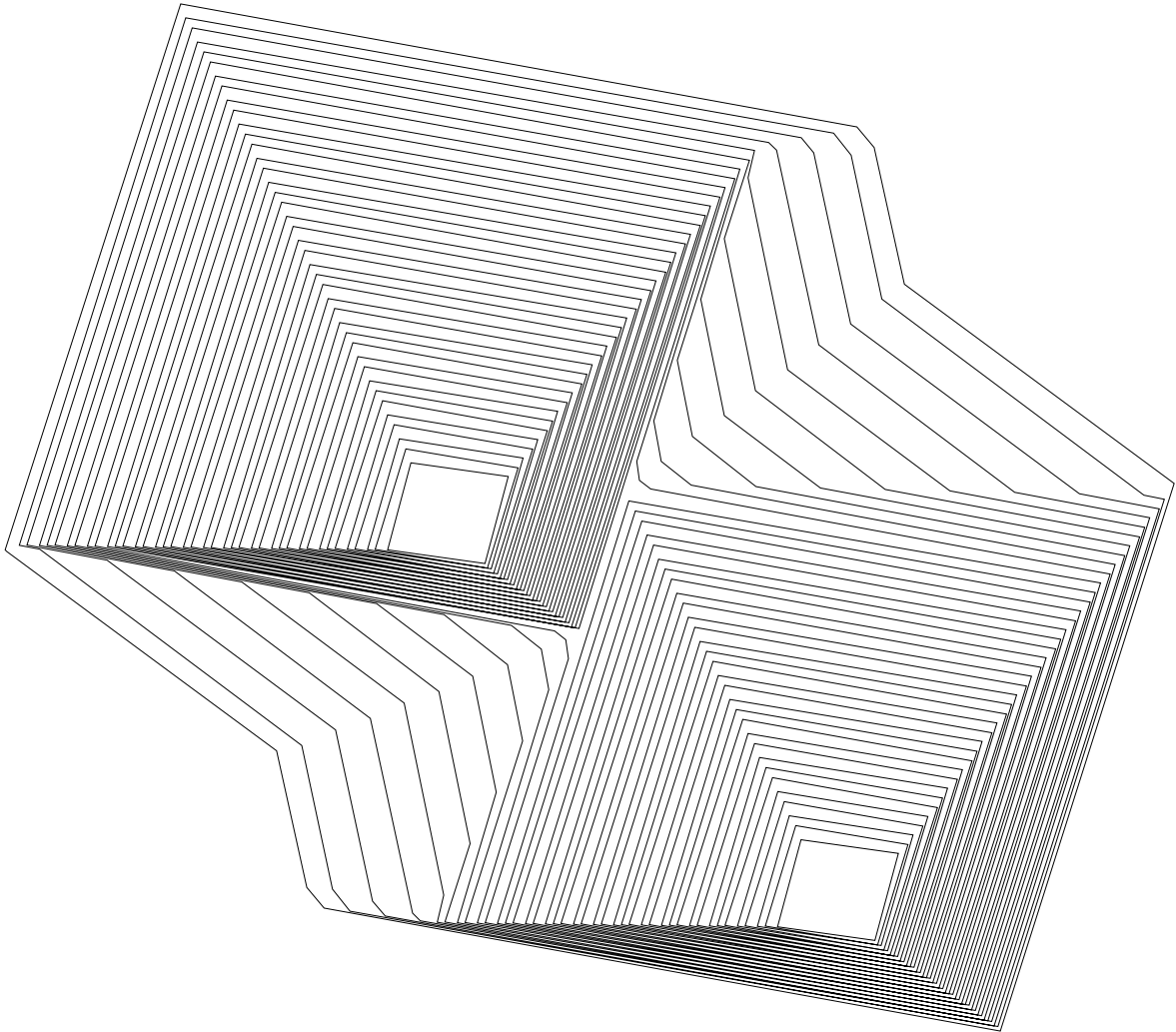

TIME: 39

<111> masks merge

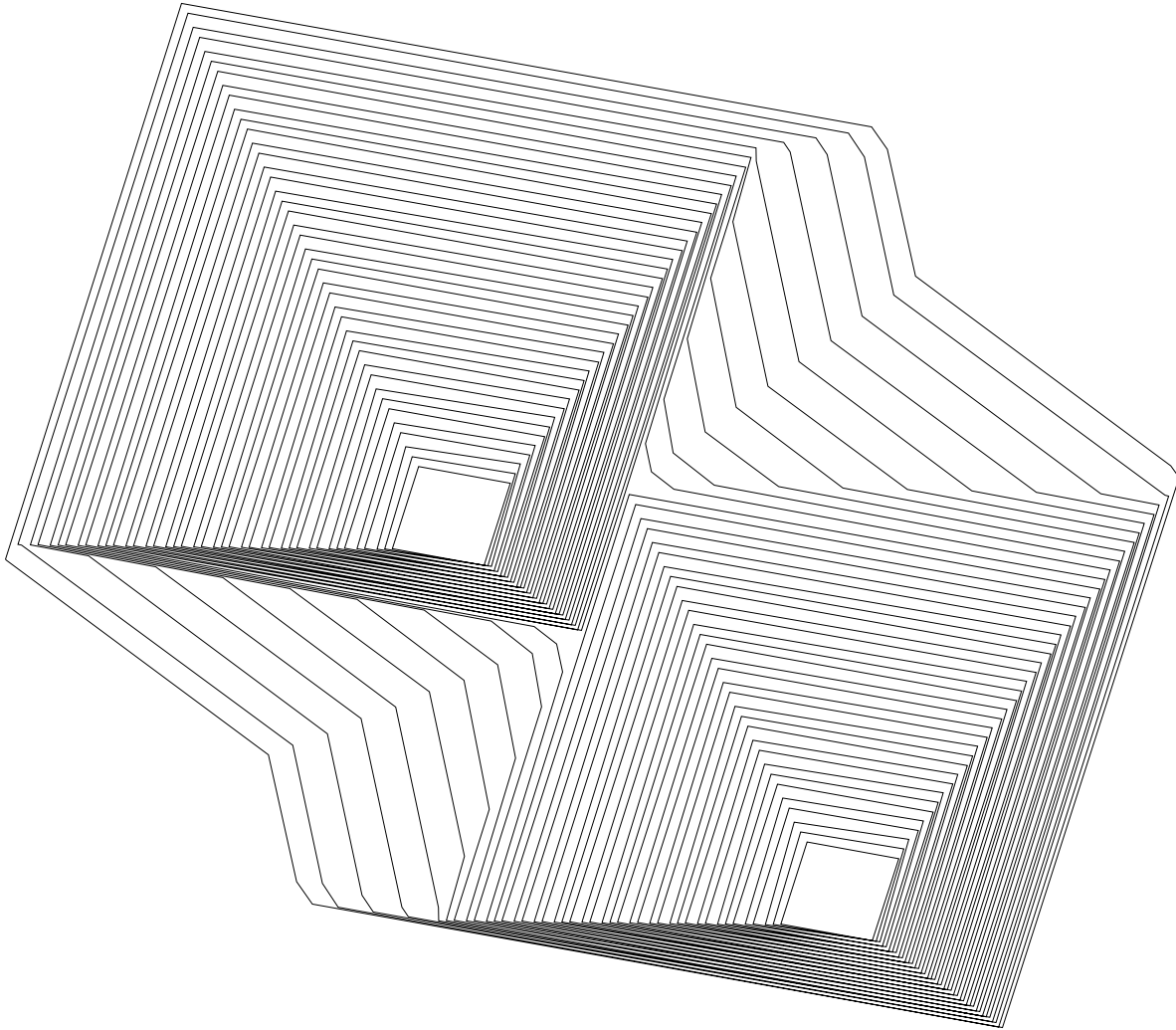

TIME: 40

$\langle 111 \rangle$  masks merge

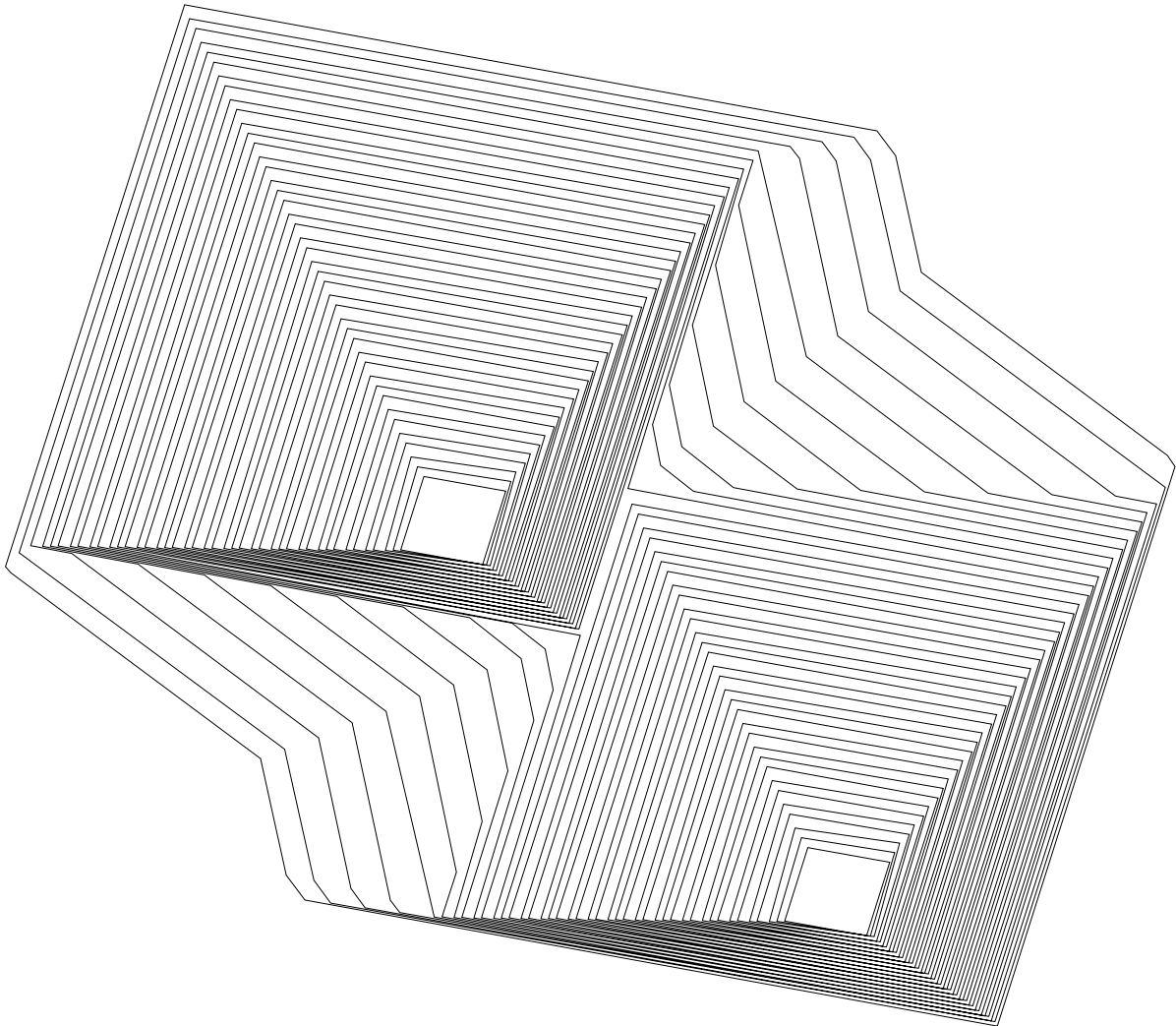

TIME: 41

$\langle 111 \rangle$  masks merge

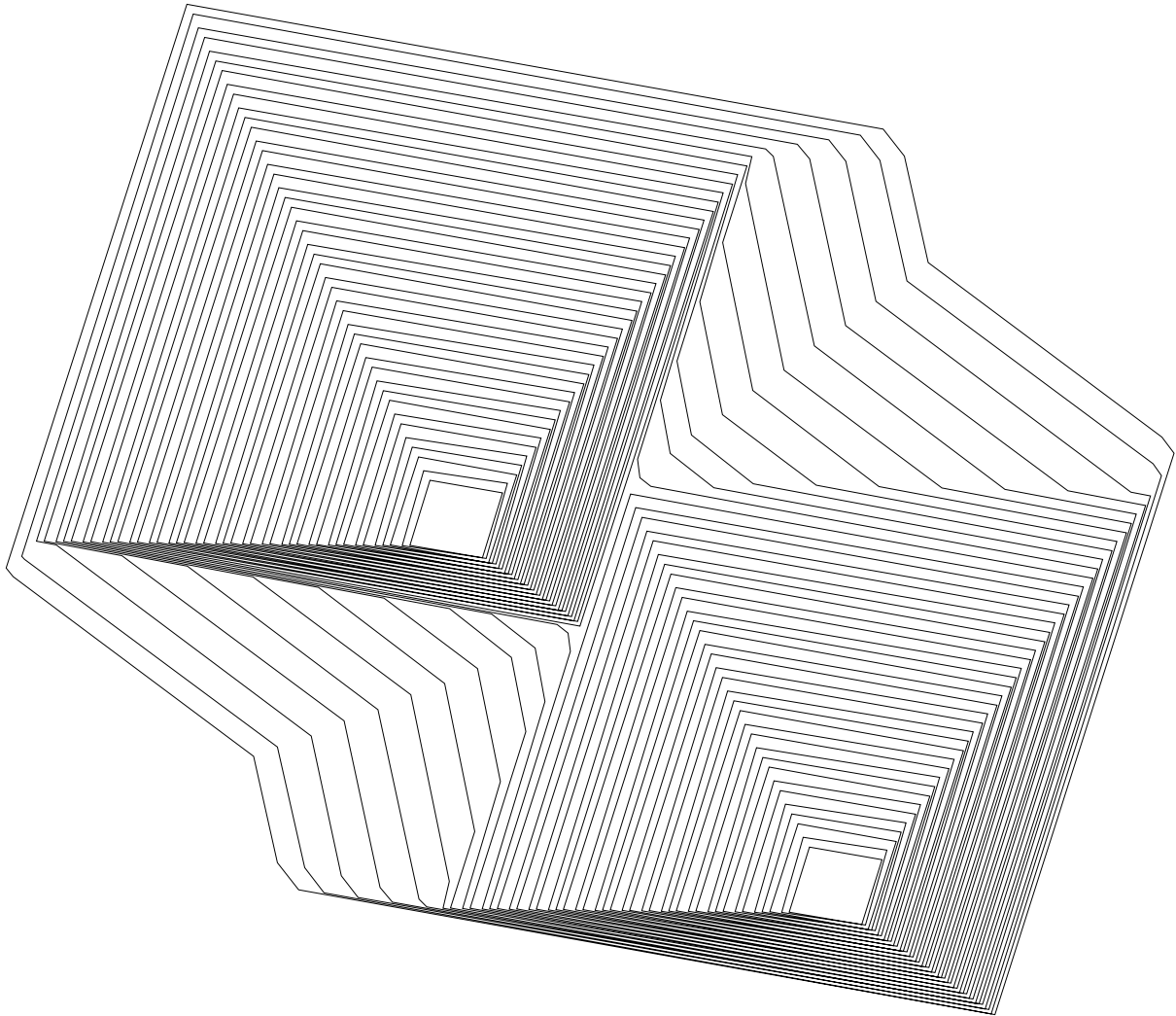

TIME: 42

<111> masks merge

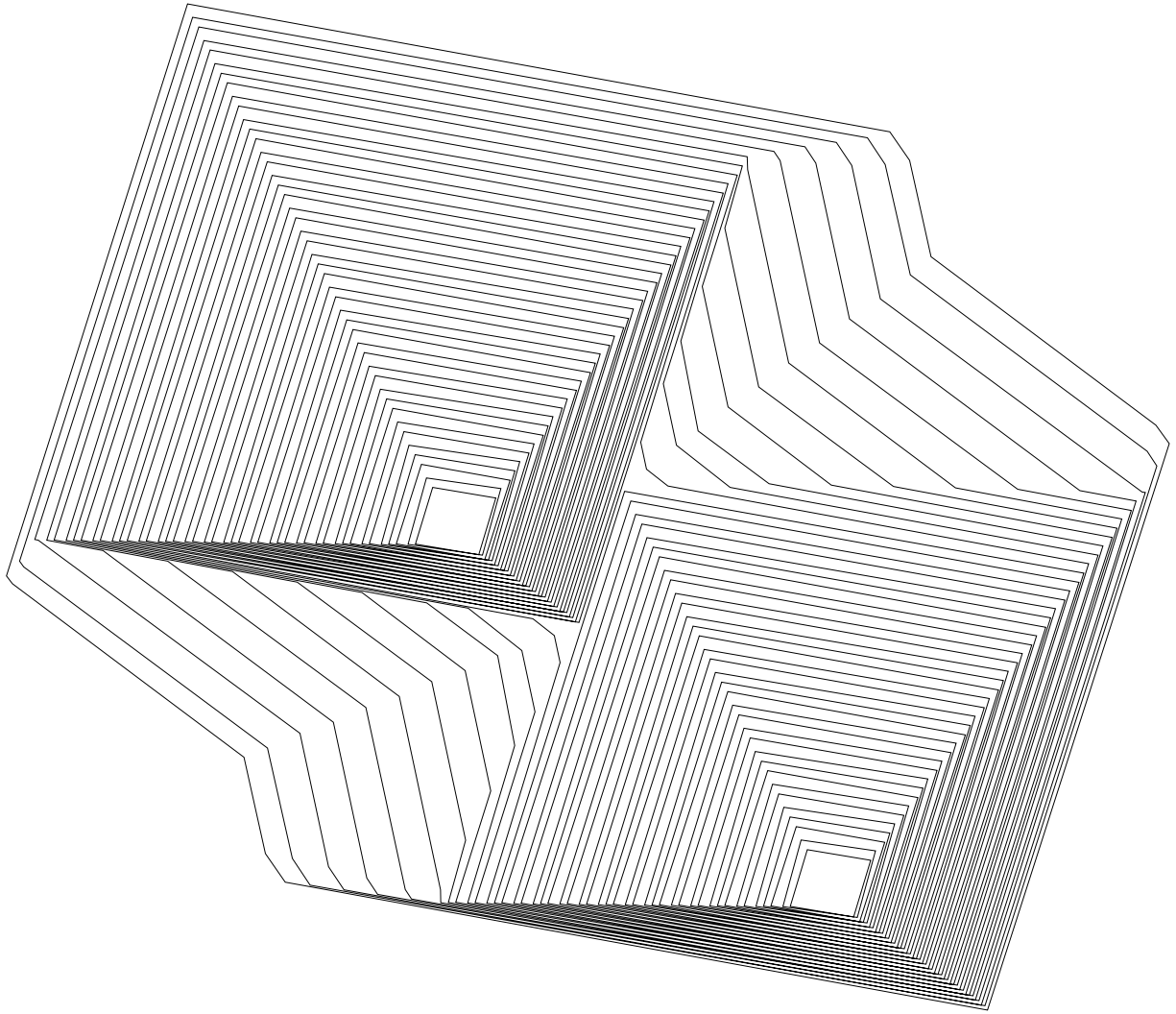

TIME: 43

$\langle 111 \rangle$  masks merge

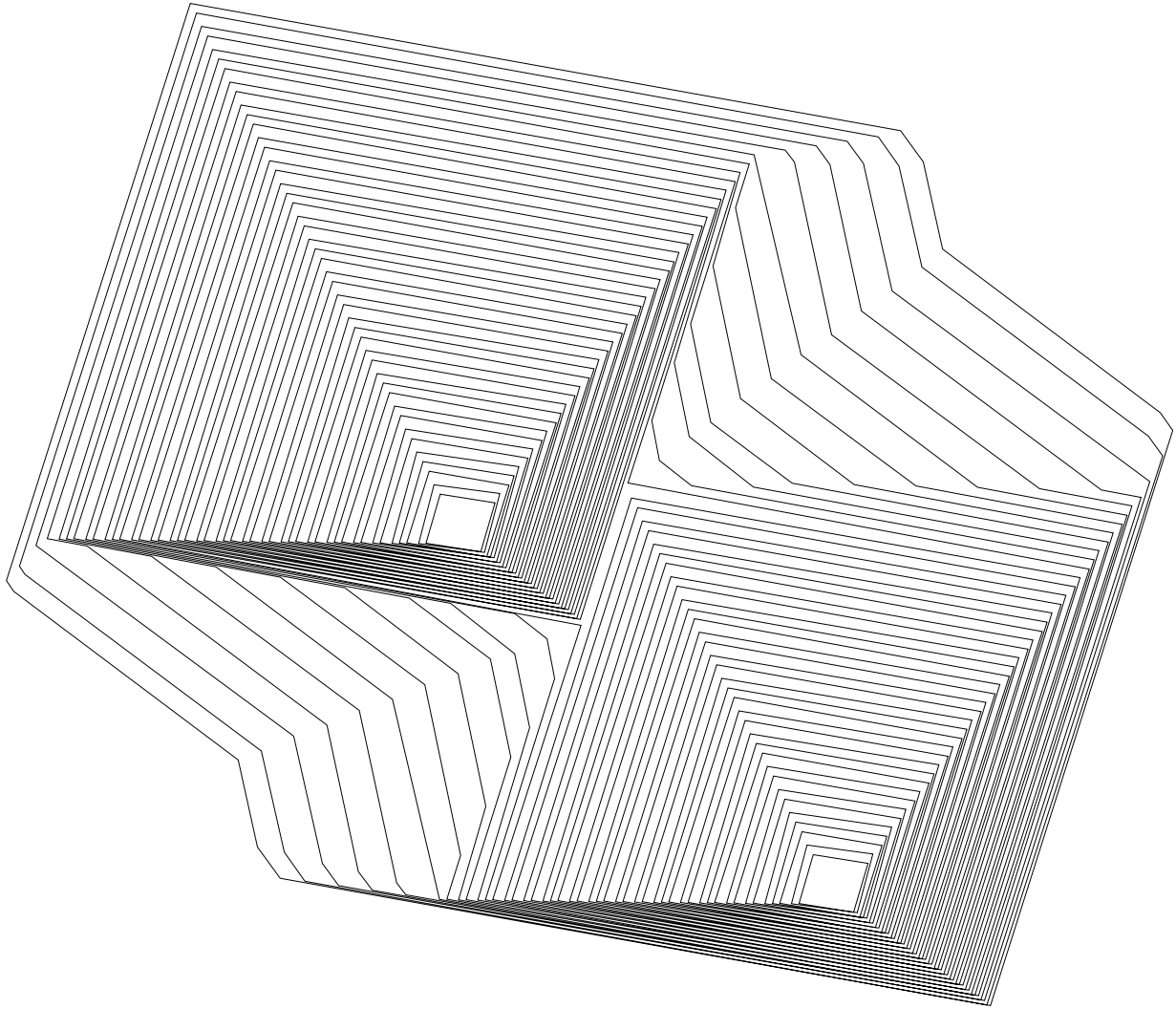

TIME: 44

$\langle 111 \rangle$  masks merge

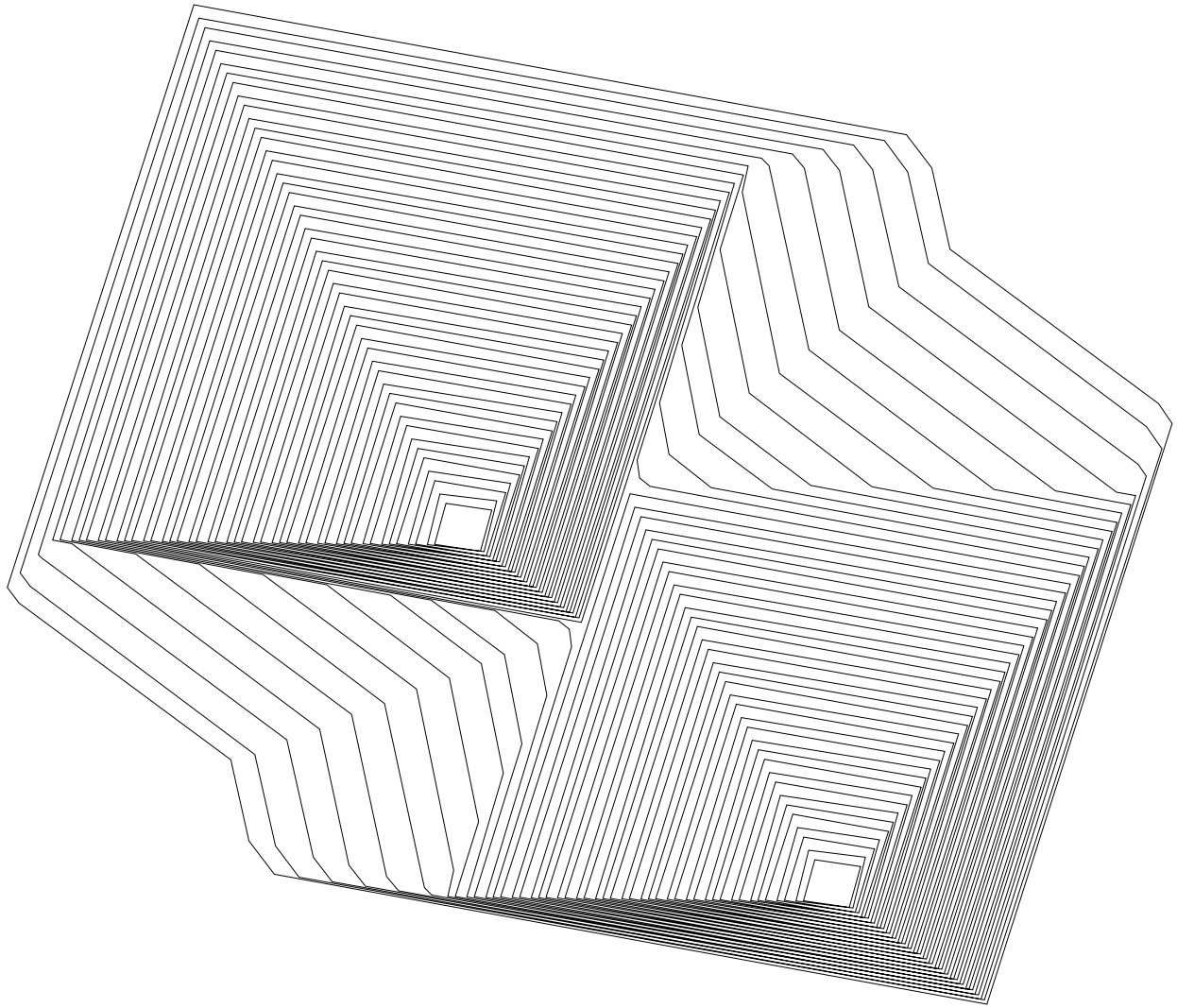

TIME: 45

<111> masks merge

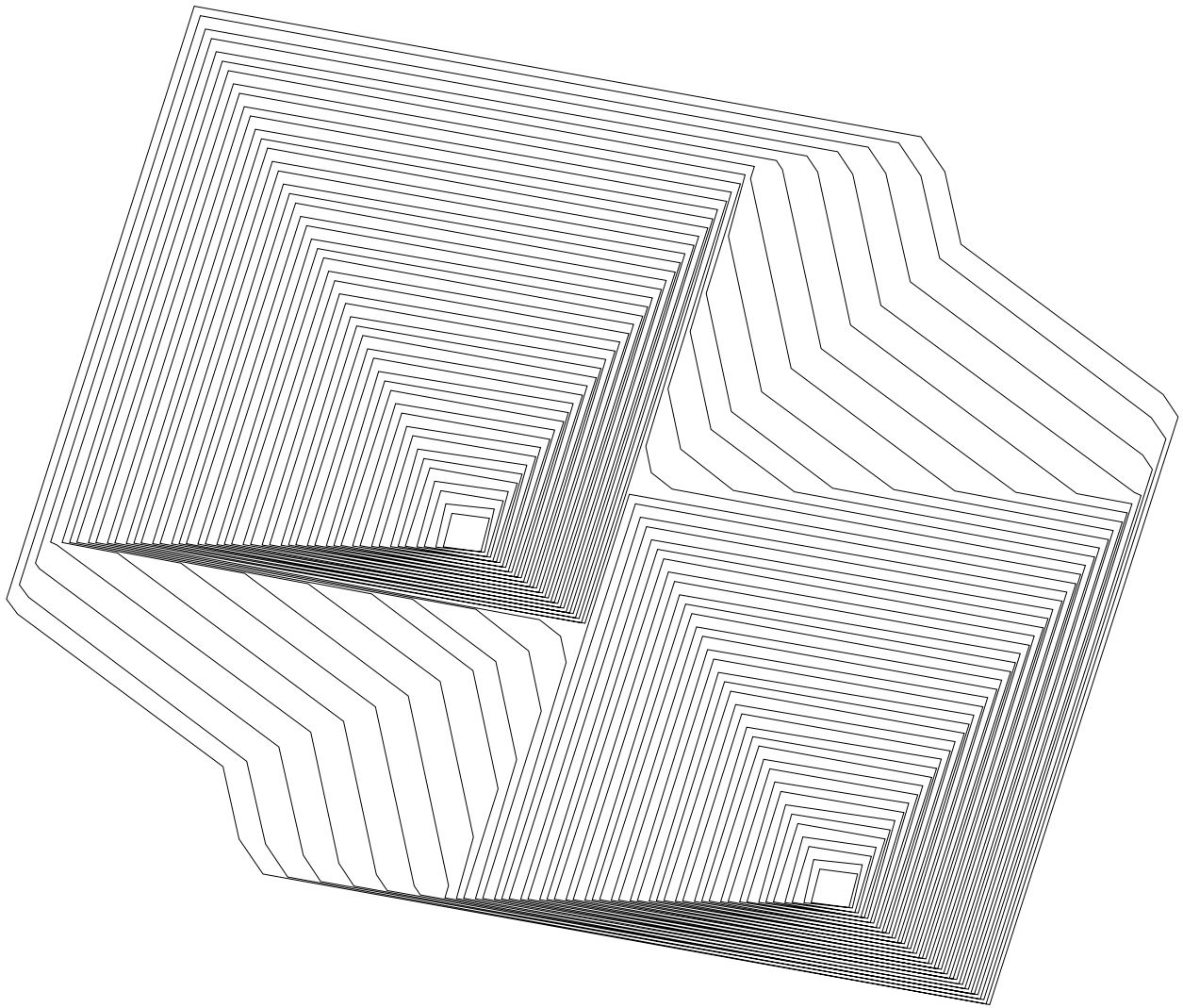

TIME: 46

$\langle 111 \rangle$  masks merge

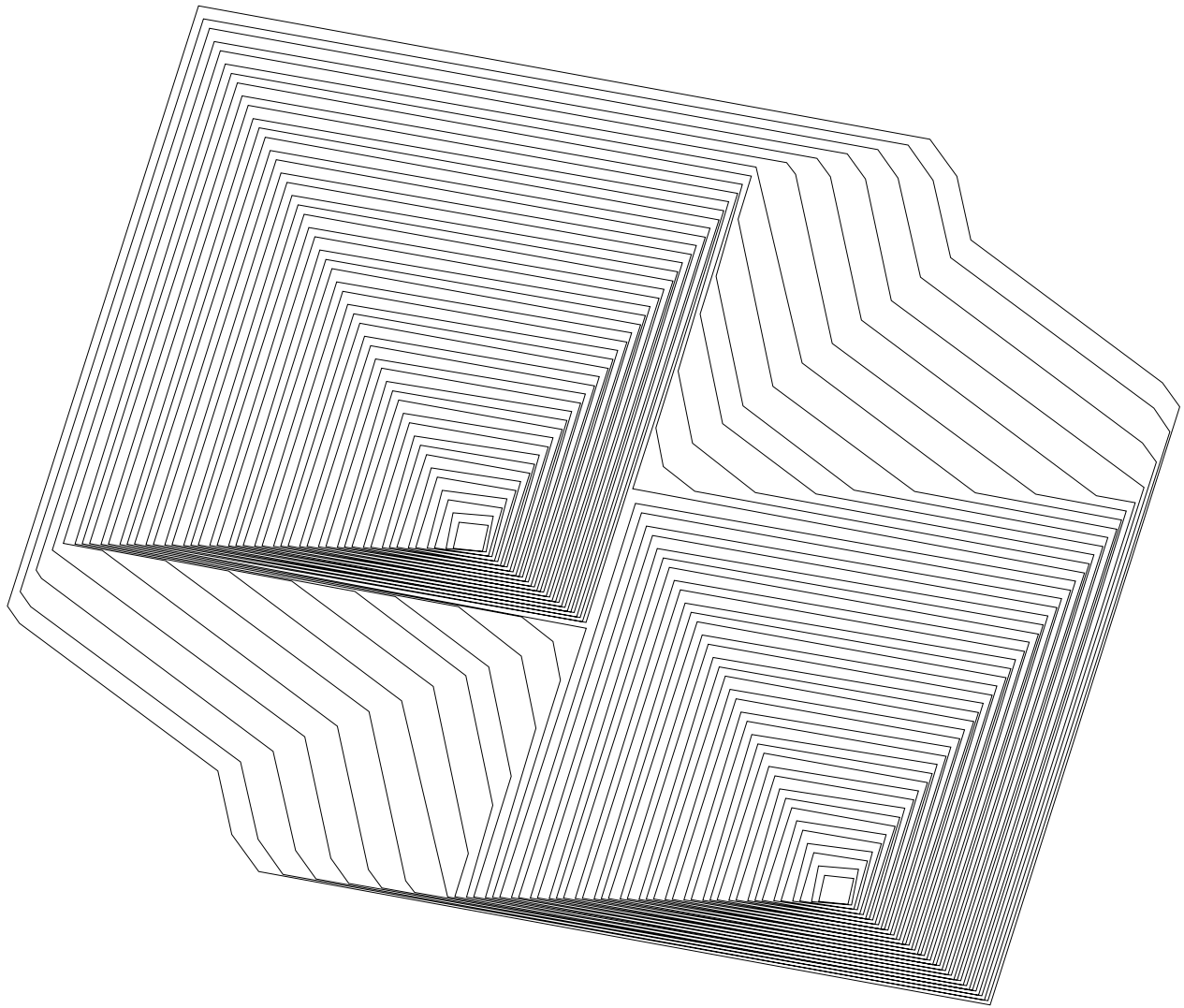

TIME: 47

$\langle 111 \rangle$  masks merge

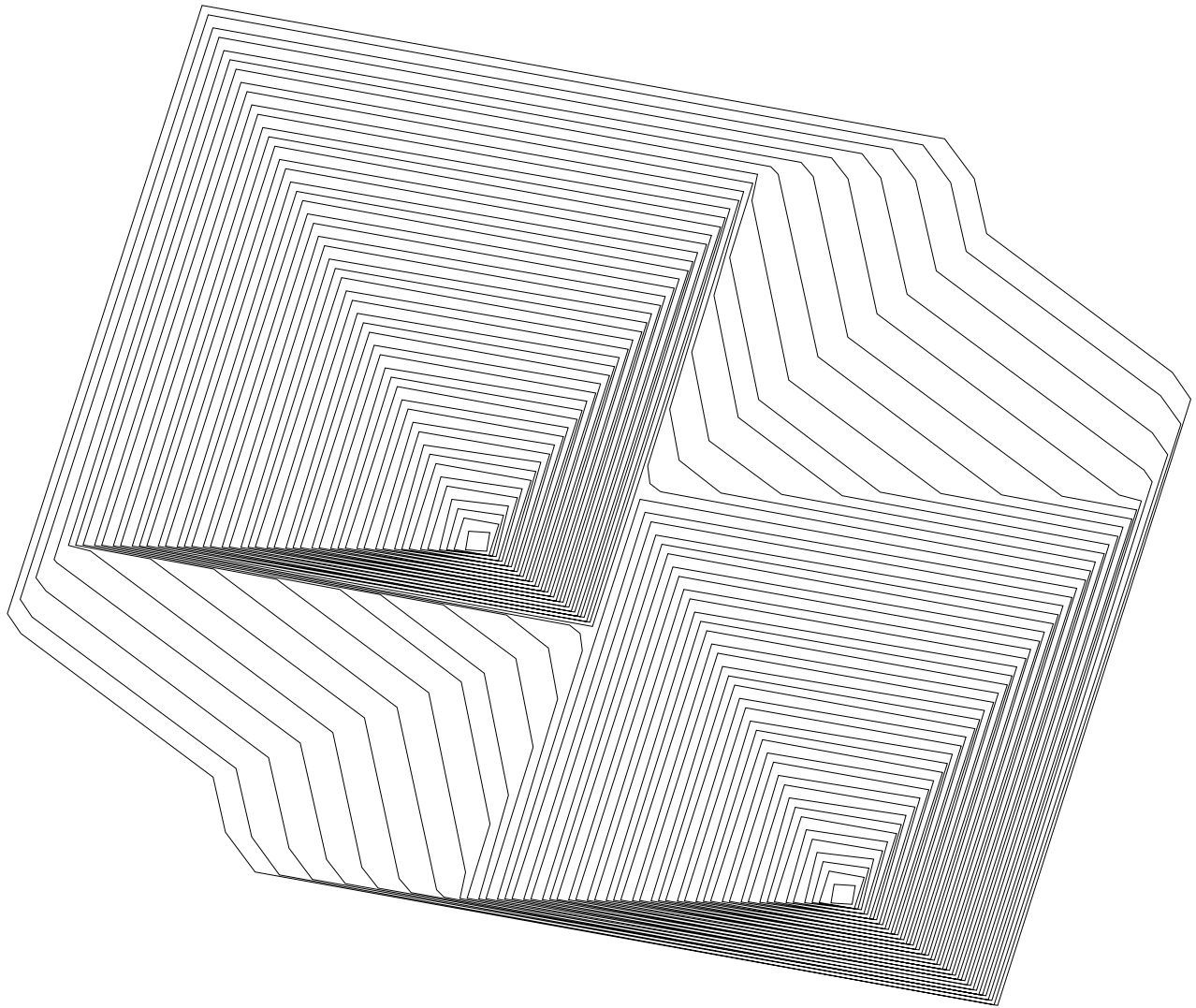

TIME: 48

$\langle 111 \rangle$  masks merge

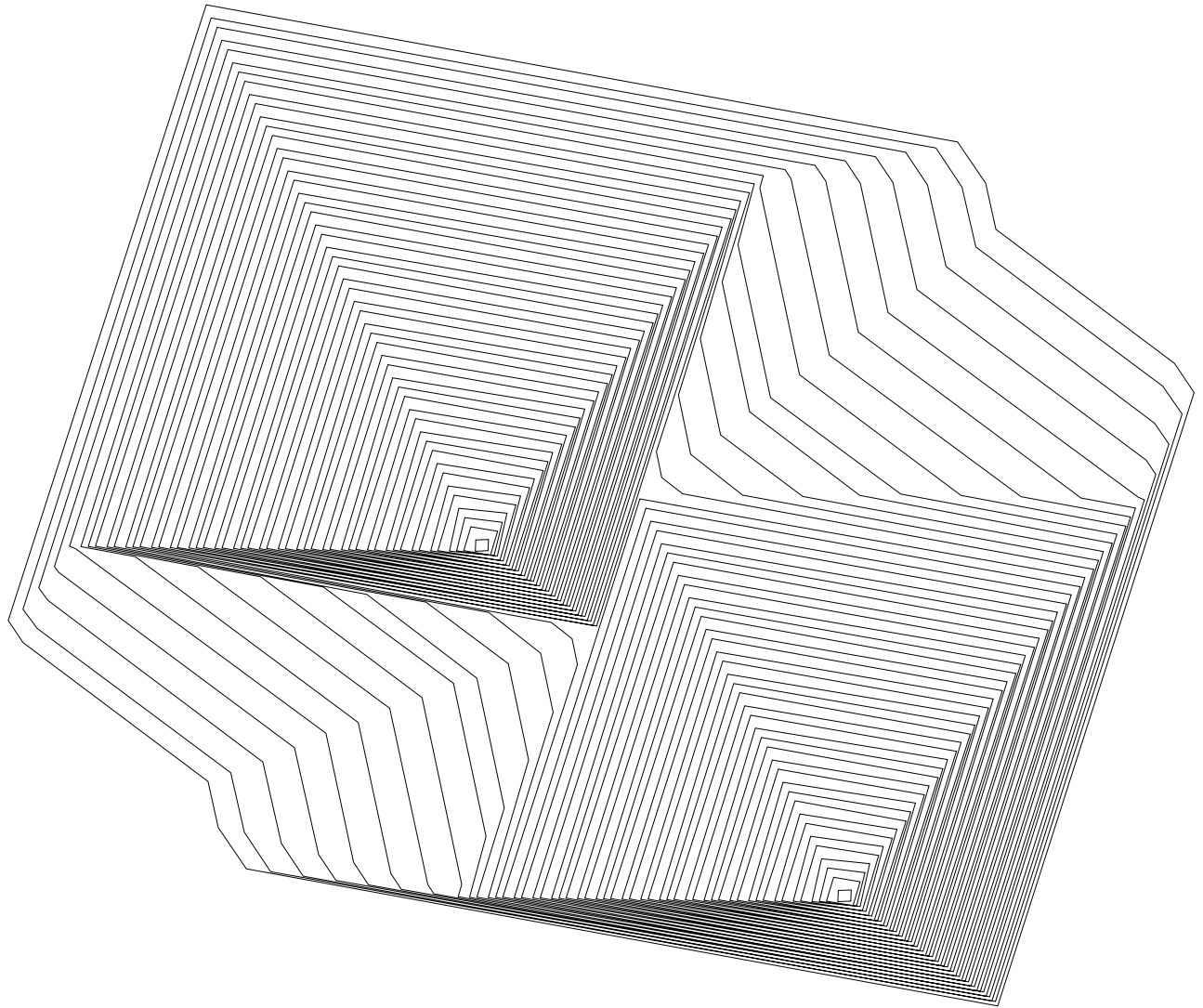

TIME: 49

$\langle 111 \rangle$  masks merge

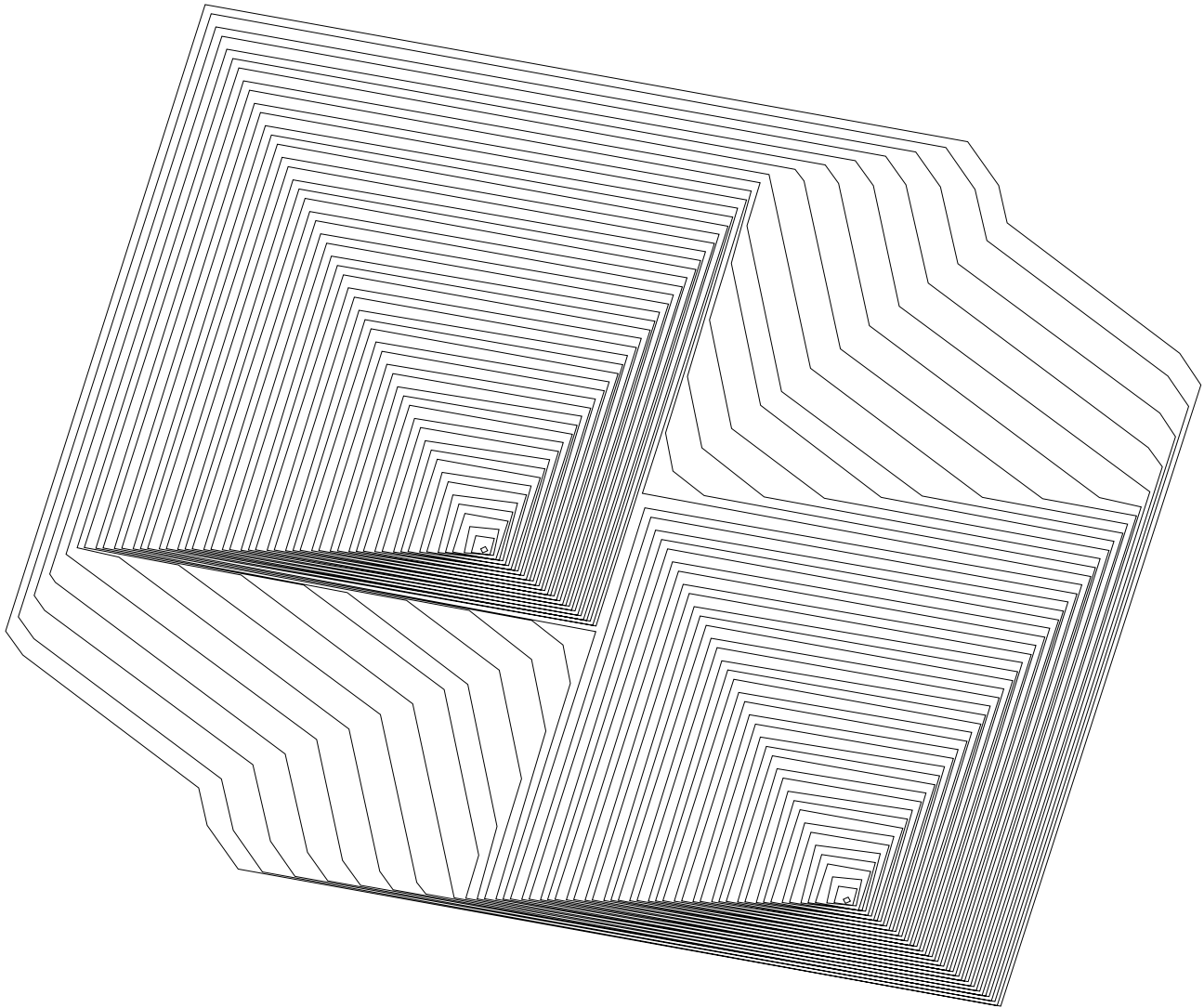

TIME: 50

$\langle 111 \rangle$  masks merge

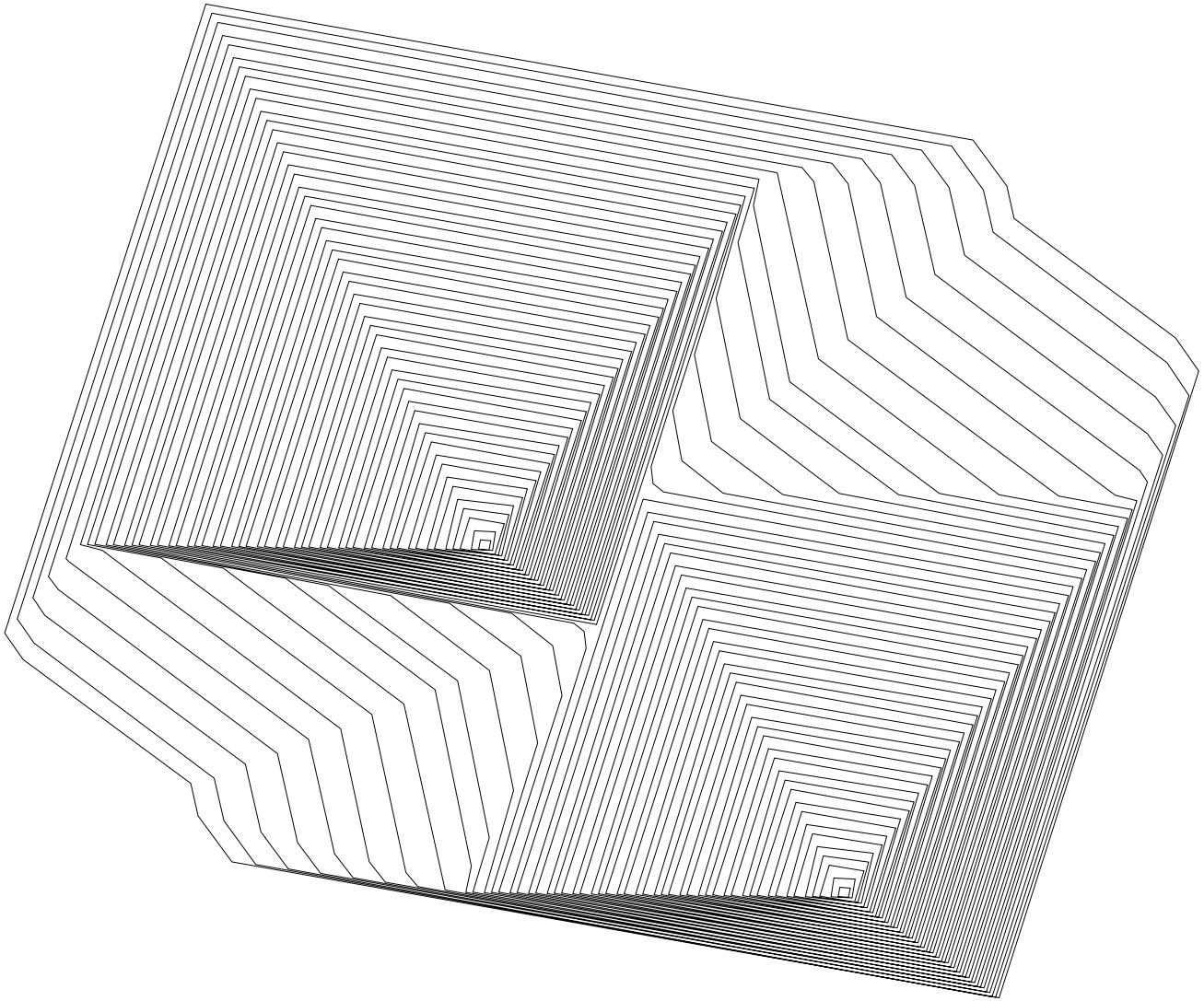

TIME: 51

$\langle 111 \rangle$  masks merge

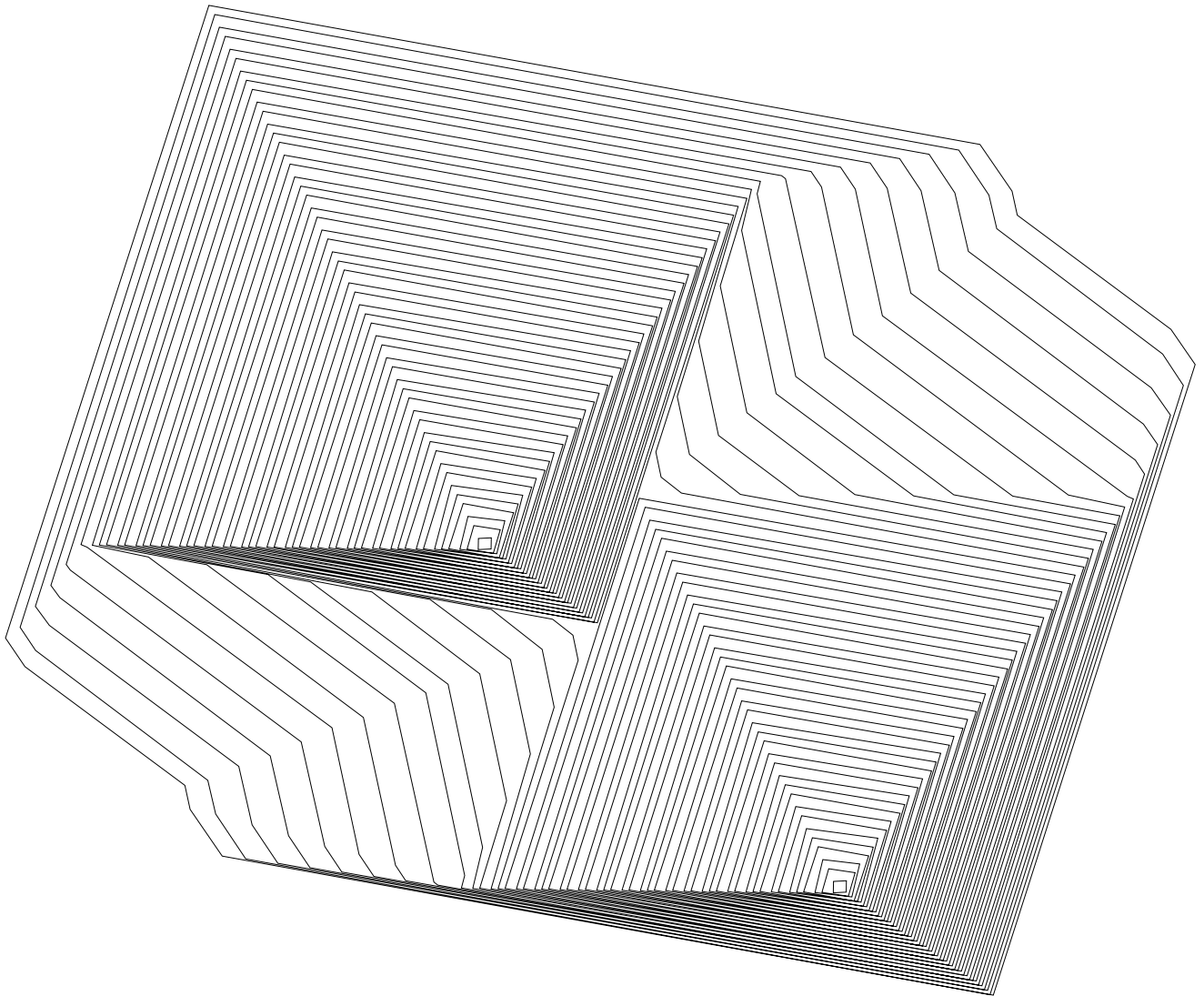

TIME: 52

$\langle 111 \rangle$  masks merge

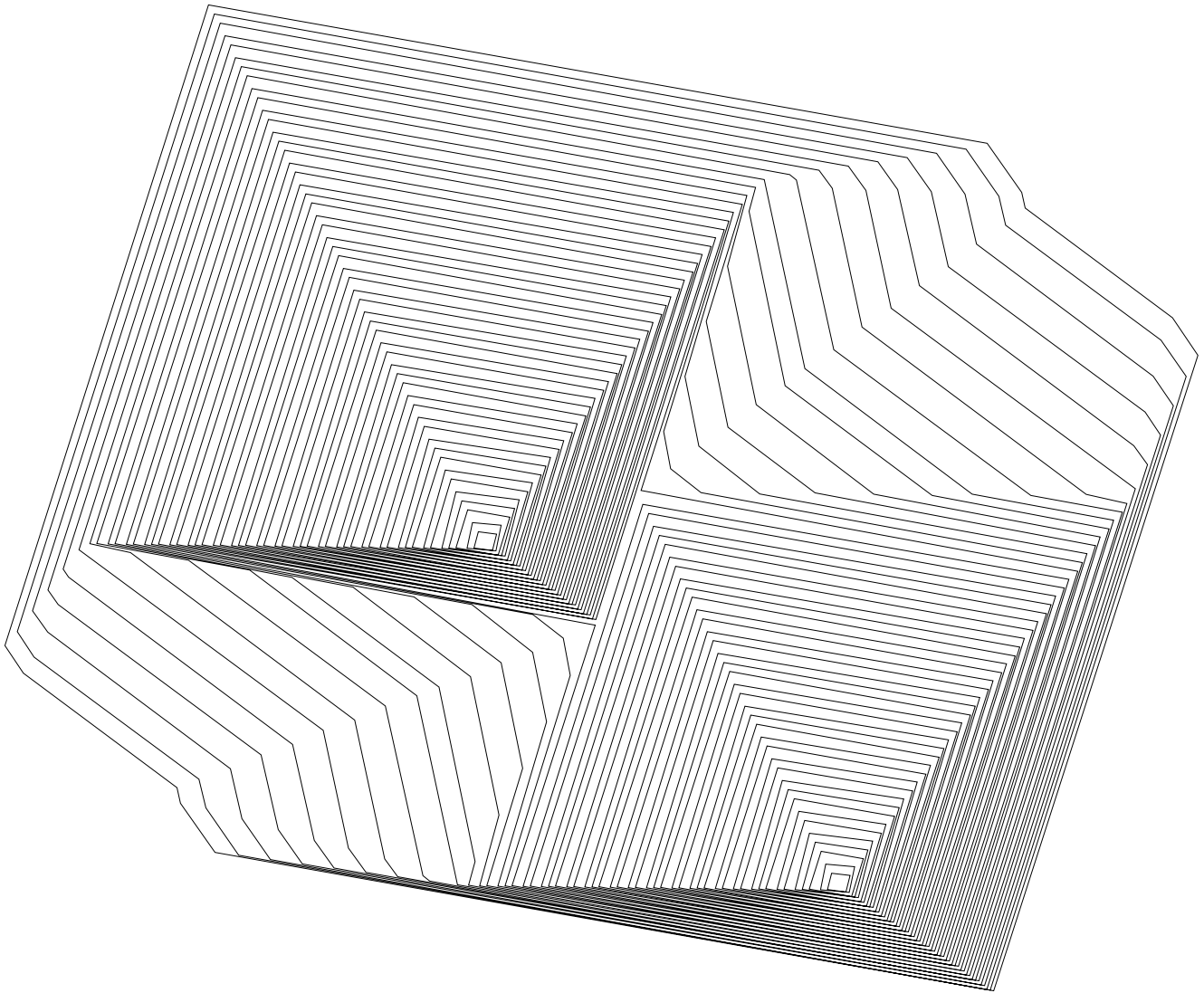

TIME: 53

$\langle 111 \rangle$  masks merge

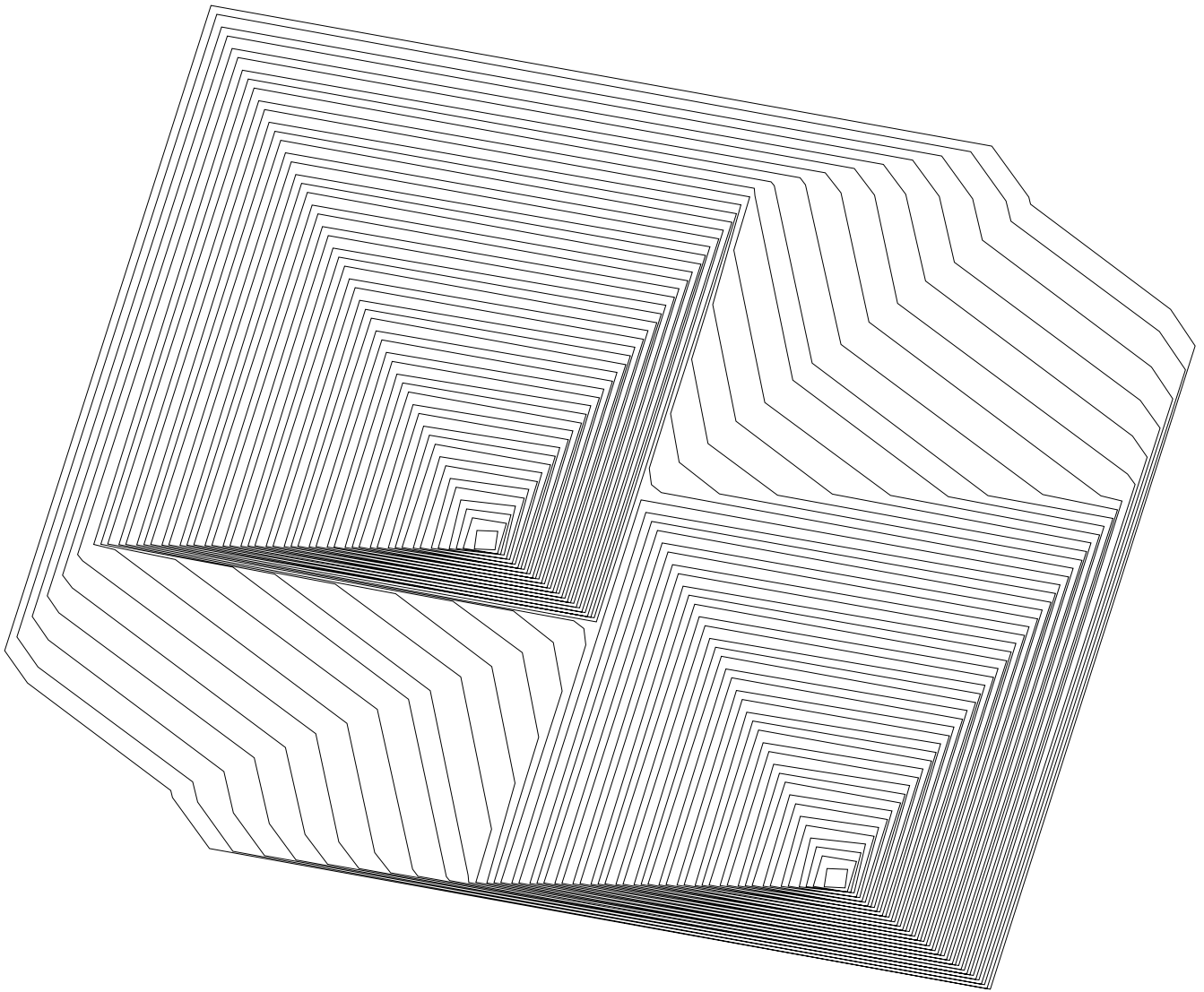

TIME: 54

<111> masks merge

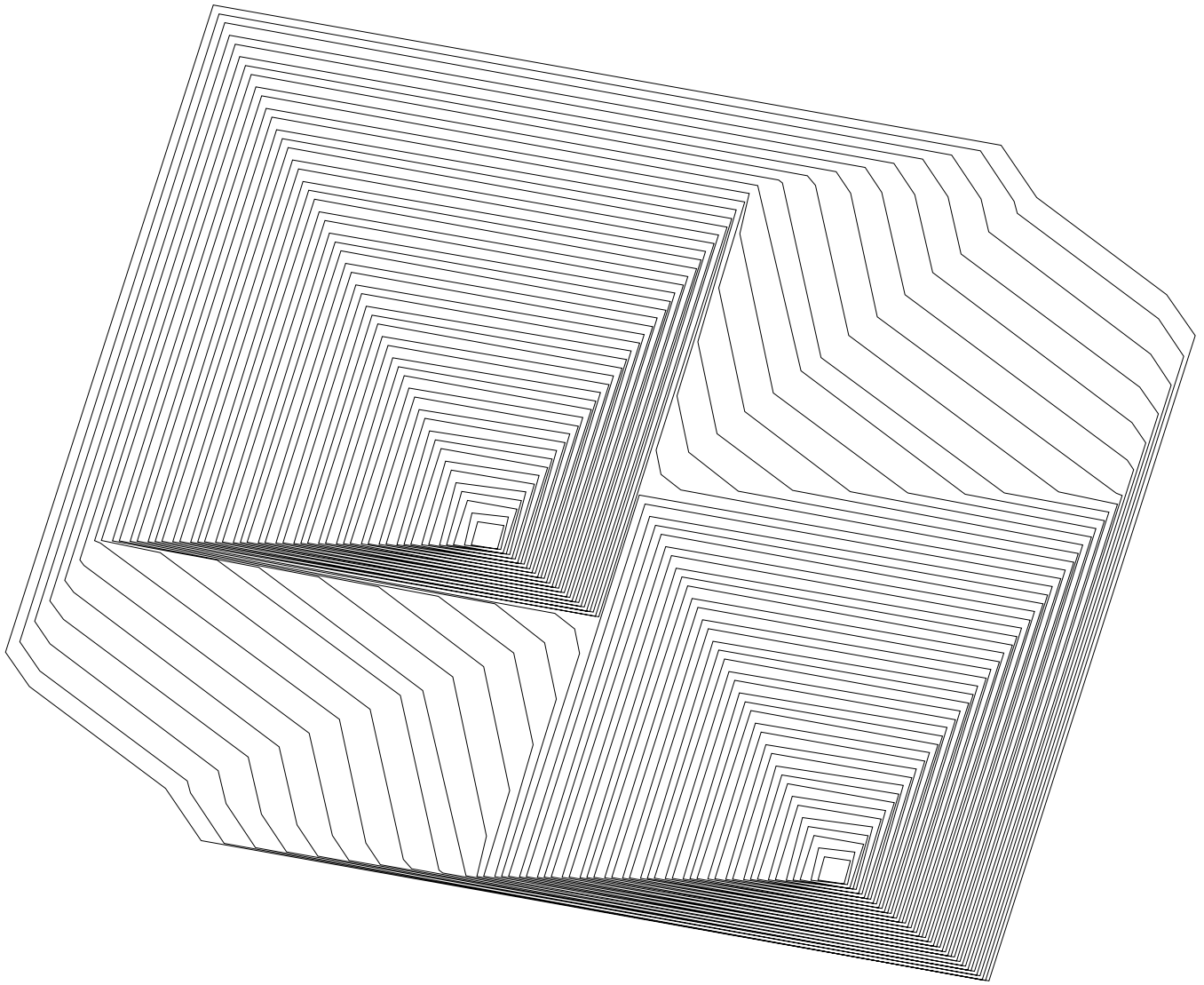

TIME: 55

$\langle 111 \rangle$  masks merge

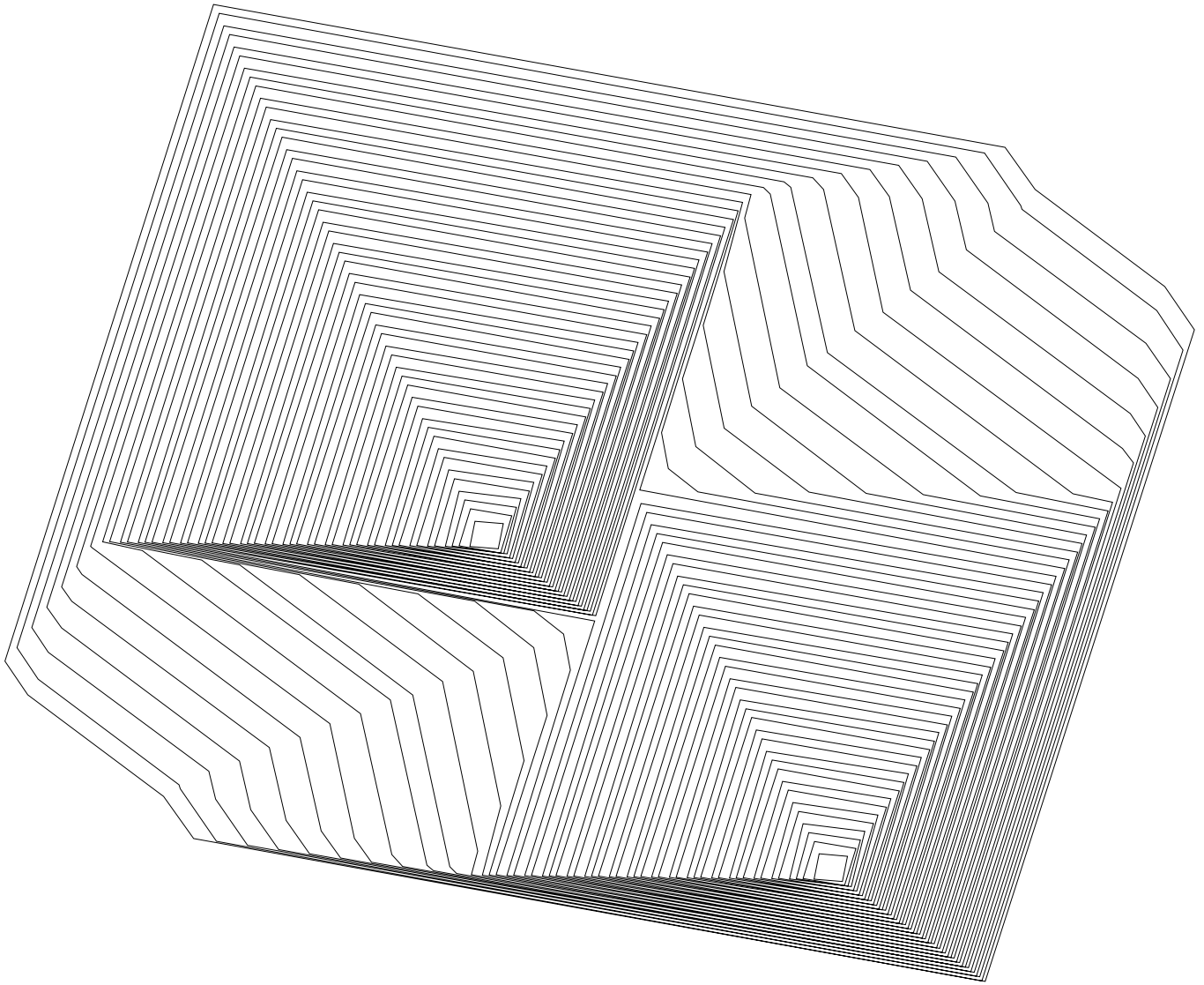

TIME: 56

$\langle 111 \rangle$  masks merge

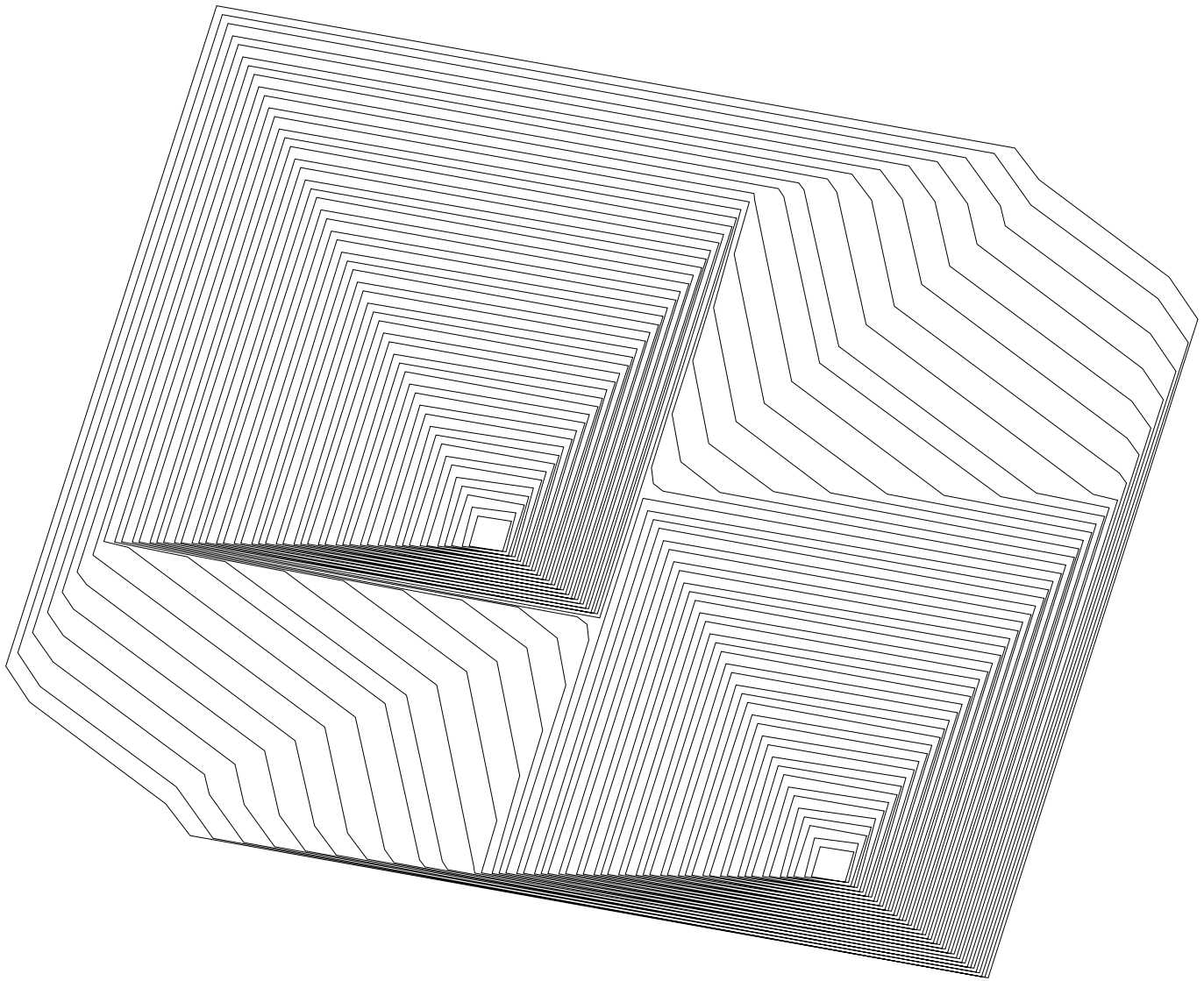

TIME: 57

$\langle 111 \rangle$  masks merge

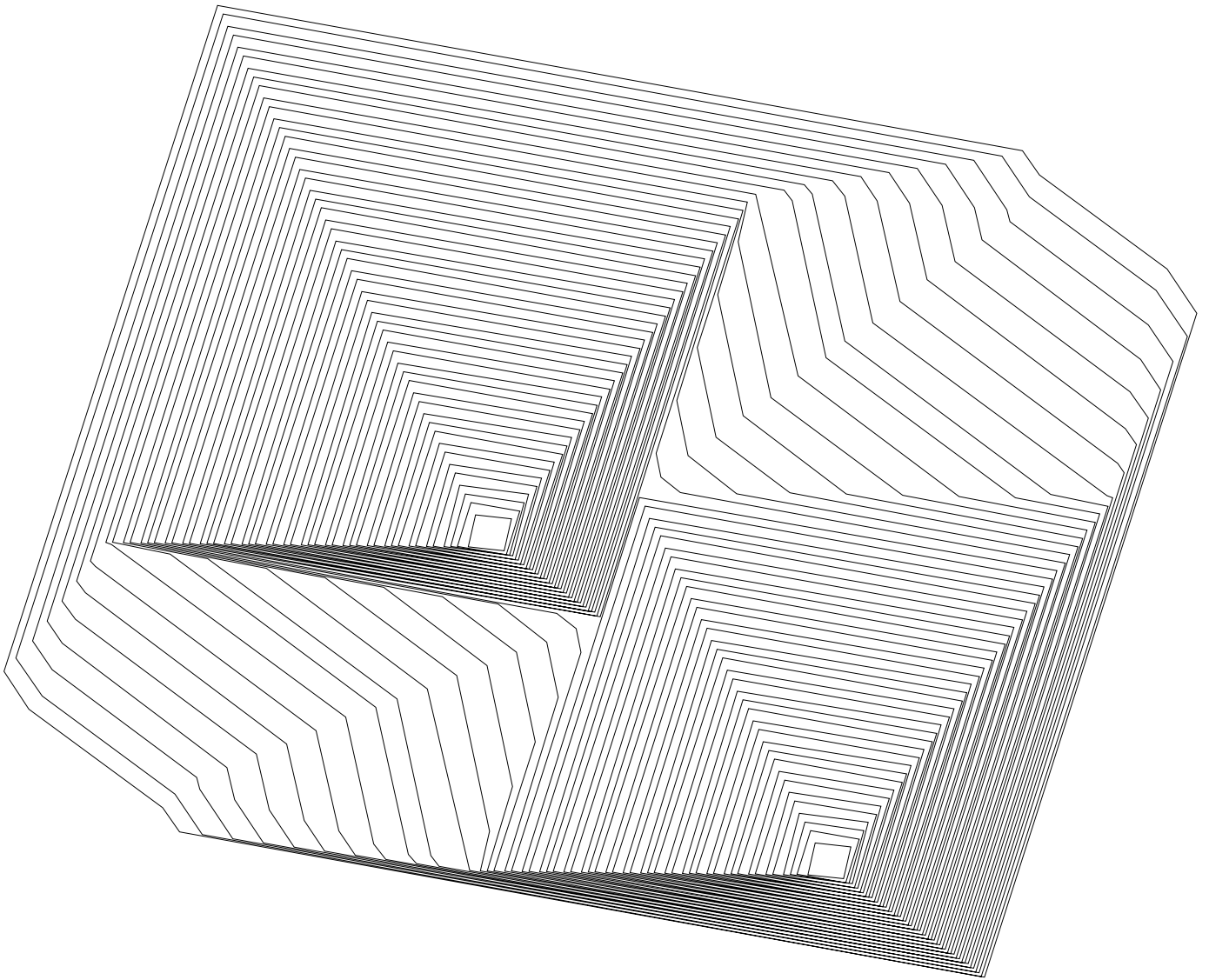

TIME: 58

$\langle 111 \rangle$  masks merge

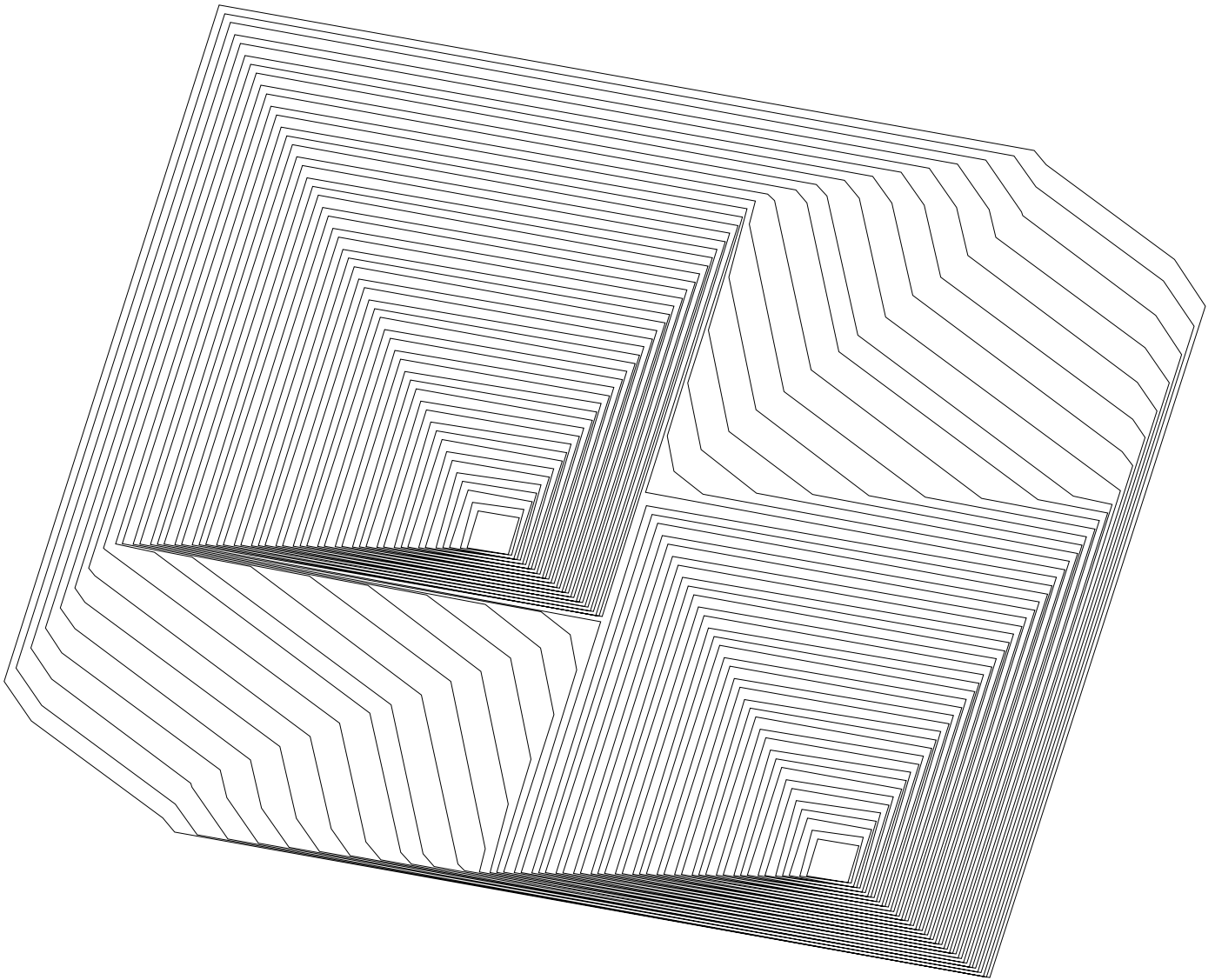

TIME: 59

$\langle 111 \rangle$  masks merge

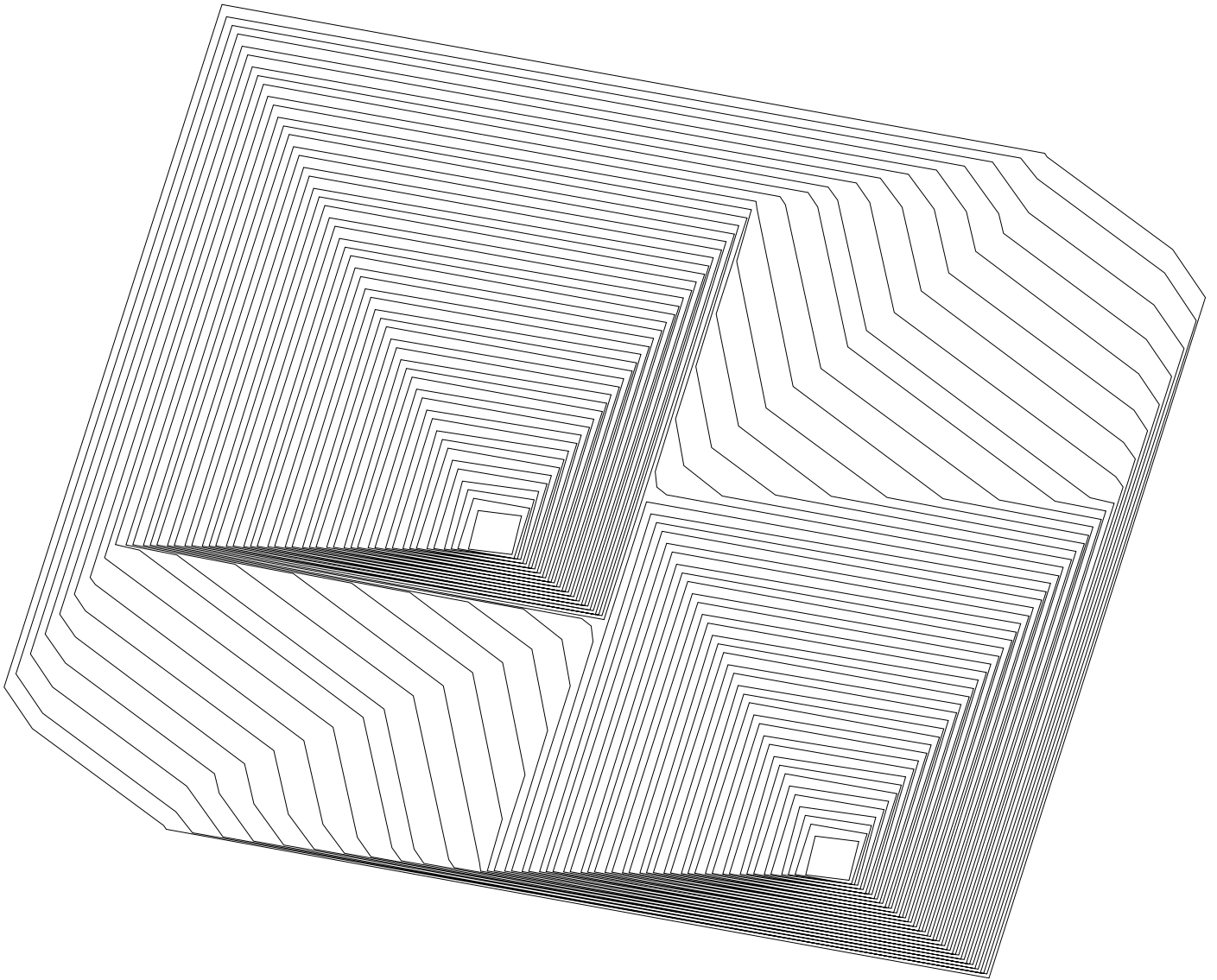

TIME: 60